

The RADIO Constructor



RADIO · TELEVISION · AUDIO · ELECTRONICS

The SATELLITE Switched FM Tuner (OSMOR)



Included in this issue
SIMPLE SQUARE WAVE GENERATOR
MAINS UNIT FOR FM TUNERS etc.
A SWITCH-TUNED SUPERHET
TRANSISTOR D.C. CONVERTER
SENSITIVE CRYSTAL RECEIVER

DATA
Publications 1'9

THE MODERN BOOK CO

TV Fault Finding. A Data Publication.
5s. Postage 4d.

Electronics Made Easy. Popular
Mechanics. 6s. Postage 8d.

**The Radio Amateur Operator's
Handbook.** Data Publication. 3s.
Postage 3d.

Television Engineers' Pocket Book.
By E. Molloy and J. P. Hawker.
10s. 6d. Postage 6d.

**An Introduction to the Cathode
Ray Oscilloscope.** By H Carter.
12s. 6d. Postage 8d.

Understanding Hi-Fi Circuits. By
N. H. Crowhurst. 23s. Postage 1s.

FM Radio Servicing Handbook. By
G. J. King. 25s. Postage 1s.

Fun with Radio. By G. Davey. 10s. 6d.
Postage 8d.

Transistors and Crystal Diodes.
By B. R. Bettridge. New Ed. 5s.
Postage 4d.

Transistor Techniques. Gernsback
Library. 12s. Postage 8d.

High Quality Sound Reproduction.
Circuits designed by Mullards. 3s. 6d.
Postage 4d.

Rapid TV Repair. By G. W. Heath.
23s. Postage 1s.

High Fidelity. By G. A. Briggs.
12s. 6d. Postage 1s.

Radio Valve Data. "W.W." 5s.
Postage 8d.

We have the Finest Selection of British and American Radio Books in the country

Complete catalogue 6d.

19-23 PRAED STREET (Dept RC) LONDON W2

Telephone PADDington 4185

MAXI-Q
REGD.

COIL PACKS

CP.3/370pF and **CP.3/500pF.** These 3 waveband Coil Packs are available for use with either 370pF or 500pF tuning condensers. The coverages are: Long Wave 800-2,000 metres, Med. Wave 200-550 metres, Short Wave 16-50 metres. Designed for use with "MAXI-Q" glass scale type S2. Retail price of each unit: 32/- plus 12/9 P.T.—total 44/9

CP.3/G. As above but with Gram position, suitable for use with 500pF tuning condenser: 39/- plus 15/7 P.T.—total 54/7

CP.3/F. This Coil Pack is for use with a 500pF tuning condenser and covers the standard Long, Med. and Short wavebands with the addition of the band 50/160 metres. This covers the Trawler band, Aeronautical and the 80 and 160 metre Amateur bands: 49/- plus 19/7 P.T.—total 68/7

CP.3F/G. As CP.3/F but with Gram position: 57/- plus 22/9 P.T.—total 79/9

CP.4/L and **CP.4/M.** These compact 4-station Coil Packs are available for either 1 Long Wave and 3 Medium Wave stations (CP.4/L) or 4 Medium Wave stations (CP.4/M). They are fully wired and require only four connections for use with any standard frequency changer valve: 25/- plus 10/- P.T.—total 35/-

CP.4L/G and **CP.4M/G.** As CP.4/L and CP.4/M but with provision for Gram position: 31/- plus 12/5 P.T.—total 43/5

See Technical Bulletin DTB.9 for details of all Coil Packs, 1/6

GENERAL CATALOGUE covering technical information on full range of components 1/- post free

DENCO (CLACTON) LTD

(DEPT. R.C.) 357/9 OLD ROAD
CLACTON-ON-SEA ESSEX

STOP PRESS: Maxi-Q Pre-set FM Tuner completely assembled, £12. Variable Version, £11. Combined Power Pack and Amplifier, £5.10.0 or in comprehensive kit form at £5

Trading Terms for direct postal orders: C.W.O. plus appropriate postal charges

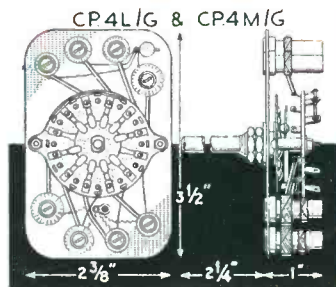

**ENTIRELY NEW RANGE
SUB-MINIATURE
CAPACITORS**

Available for the first time in this country, these are the product of a famous manufacturer. The following values are now in stock:

25uF 6V	5uF 12.5V
16uF 12.5V	5uF 40V
8uF 25V	2.5uF 25V
8uF 6V	1.6uF 6V

All at 4/- each

(See review on page 232) Nov.

Trade enquiries invited

T.C.C. Sub-miniatures. 32uF 1.5V, 6uF 3V, 10uF 3V, 2uF 12V, 4uF 12V, 8uF 15V all 4/9 each

TRANSISTORS

*Yellow/Green (Audio)	... 10/-
Blue Spot (1.6 Mc/s)	... 15/-
*Yellow/Red (2.8 Mc/s)	... 21/-

*With data

THREE DEE KIT ... £5.2.6

(Instructions 1/-)

COMPANION KIT £5.6.6

(Instructions 6d.)

RADIOSETTE KIT £2.3.0

All parts sold separately
Price lists available

TRANSISTOR HOLDER. Enable transistors to be plugged in and out like valves, without danger from heat of soldering iron. For any type of transistor. Recommended by R.C. (June). 1/- each, 6 for 5/6, 12 for 10/9

**"THE MERCURY"
FM SWITCHED TUNER**

(All parts as specified)

Complete front end (ready built, with 2 valves)	... £6.5.0
Coils, chokes and transformers	... £1.4.6
Condenser set	... 9/8
Resistor set	... 5/-
All other components (including valveholders, diodes, knob, wire, etc.)	16/7
Complete kit with 2 front end valves but less EF80's	... £9.0.0
Complete Power Pack kit	£2.1.9
All other Jason components stocked	

CRYSTAL SET KIT ... 14/3

Tuneable over medium waveband. Using HAX (Teletron) Coil. Complete with specially designed plastic case, with hinged lid, silk screened dial, chassis, and A/E and phone sockets. Cream finish. (Case only, 5/9)

PRESET CRYSTAL KIT 8/-

For Home and Light on medium waveband. No case or chassis.

DUAL-WAVE CRYSTAL KIT 12/-

Earphones (h.r.), 16/-

SCREWDRIVER KIT ... 12/-

3 screwdriver blades, 2 Phillips blades, 2 bradawls. In wallet

NEW TRANSISTOR COMPONENTS

Volume Controls. Only 3/4" diameter and 1/4" depth. Full length spindle (2"), 1/2, 1 and 2MΩ. Log track. Unrepeatable at this price 4/3 only

Paper Condensers. Approx. 7/8" diameter and 7/8" length, 0.01, 0.001 and 0.002μF... 8d. each Also 0.005μF (1/4" dia. x 1 1/4") 7d. ea.

FILE KIT 12/6

6 wooden-handled files. In wallet

"4 IN 1" SCREWDRIVER 3/6

2 blades, bradawl and file in hollow handle

FUSEDRIIVER 2/9

Containing supply of fuse wire in screwdriver handle

MAINS NEON TESTER 5/3

Screwdriver with neon bulb in the plastic handle. Fully insulated

FLEXIBLE SCREW-DRIVER 7/9

Ideal for those awkward corners

LITESOLD SOLDERING IRON.

The smallest made. 6" long, weighs 1/2oz. With 1/8" permanent non-wearing bit. Ideal for transistor assemblies. 21/6 (state voltage). Available for mains or 6 volts.

MULTICORE SOLDER, 4d. per yard (50/50)* 20ft reels (60/40 high tin) 2/6

*This is the new "SAVBIT" solder, which prolongs the life of the bit up to ten times. Also available in 1lb reels at 14/9

CHASSIS CONSTRUCTION KIT IDEAL FOR THE EXPERIMENTER

Consisting of 11 pairs of aluminium channels which can be put together to make chassis of almost any size. Can be used over and over again. Price 30/- complete in box. (See page 232 Nov.)

TYGAN—the non-creasing, fadeless, washable speaker fabric in 6 distinctive patterns. Approx. 3/9 square ft. Send 1/- for samples and quotation for size you require (credited on return). See page 840 of July issue.

NEON INDICATORS

Miniature mains neon indicators with built-in resistor. Domed front with chrome bezel. Only 1" length and 1/2" diameter.

Opal, red or amber, 3/10, green, 4/7

THE WALTER TAPE RECORDER

A new portable instrument. In smart two-tone case. Uses only two controls. Complete with 600ft tape, spare spool, microphone, etc.

Only 39 guineas complete

SPECIAL OFFER

Recording Tape by famous manufacturer. 1,200 feet on 7" standard spool.

Limited stock at 23/- each

(Normal price 35/-)

Send for Catalogue price 5d.

Please add postage to above prices

R. Fagelston (MAIL ORDER)

46 HARDWICKE ROAD • LONDON N13

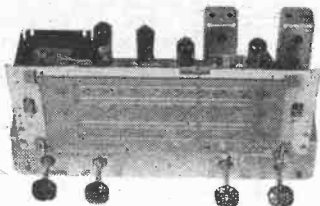

1958 RADIOGRAM CHASSIS

THREE WAVEBANDS S.W. 16 m.-50 m. M.W. 200 m.-550 m. L.W. 800 m.-2,000 m. FIVE VALVES LATEST MULLARD ECH42, EF41, EBC41, EL41, EZ40 12 month Guarantee. A.C. 200/250V, 4-way switch. Short-Medium-Long-Gram. A.V.C. and negative feedback. 4.2 watts. Chassis 13 1/2" x 5 1/2" x 2 1/2". Glass dial 10" x 4 1/2" horizontal or vertical available. 2 pilot lamps. Four knobs, walnut or ivory, aligned and calibrated. Chassis isolated from mains. Immediate Delivery

BRAND NEW £10.10.0 Carr. 4/6

TERMS: Deposit £5. 5. 0 and 6 monthly payments of £1 MATCHED SPEAKERS 8" 17/6, 10" 25/-, 12" 30/-

COLLARO HIGH FIDELITY AUTOCHANGER

MODEL RC456

For 7", 10", 12" Records 13, 35, 45, 78 r.p.m.

4 SPEEDS — 10 RECORDS WITH STUDIO "O" PICK-UP XTAL BRAND NEW IN MAKER'S BOXES

OUR PRICE £9.15.0 Post free

Terms: Deposit £5.5.0 and 6 monthly payments of £1 Suitable player cabinets ... 49/6 Amplifier player cabinets ... 63/-

B.S.R. MONARCH 4-SPEED AUTOMATIC RECORD CHANGERS

1958 MODELS

Brand new and fully guaranteed 12 months NOT JOB LINE REJECT STOCK

Designed to play 16, 33, 45, 78 r.p.m. Records 7", 10", 12". Lightweight Xtal pick-up, turnover head, two separate sapphire styli, for standard and L.P.

OUR PRICE £8.15.0 each. Post free

Terms: Deposit £5 and 5 monthly payments of £1 Suitable player cabinets ... 49/6 Amplifier player cabinets ... 63/-

BUILD THIS REPRODUCER BARGAIN

SPECIAL SINGLE PLAYER KIT FAMOUS MAKER'S SURPLUS STOCKS

4-speed Gram-Pick-up Unit ... £4. 12. 6 Handsome portable case 17 1/2" x 13 1/2" x 7" ... £2. 5. 0 Ready-built powerful amplifier with valves and loudspeaker ... £3. 12. 6

All available separately or if all purchased together

£9.15.0 complete kit post free

I.F. TRANSFORMERS 7/6 pair

465 kc/s slug tuning miniature can 2 1/2" x 1" x 1". High Q and good band width. By Pye Radio. Data sheet supplied.

Wearite M800 I.F. transformers 465 kc/s, 12/6 pair Wearite 550 I.F. transformers 465 kc/s, 12/6 pair

NEW AND ENLARGED SHOWROOMS NOW OPEN

C.R.T. ISOLATION TRANSFORMERS

For Cathode Ray Tubes having heater-cathode short circuit and for C.R. Tubes with falling emission.

Type A. Low leakage windings. Ratio 1:1.25 giving a 25% boost on secondary: 2V, 4V, 6.3V, 10.3V, 13.3V, 10/6 each; ditto with mains primaries, 12/6 each. All with tag panel and solder tags

Type B. Mains input 220/240V. Low Capacity. Multi Output 2, 4, 6.3, 7.3, 10 and 13V. Input has two taps which increase output volts by 25% and 50% respectively. This transformer is suitable for all cathode ray tubes. With tag panel, 21/- each Ditto for 6 volt tubes, only 17/6 each

Type C. Low capacity wound transformer for use with 2V tubes with falling emission. Input 220/240V. Output 2-2 1/2-2 1/2-2 1/2-3V at 2A, 17/6 each All isolation transformers are individually boxed, labelled and clearly marked with relevant data.

NOTE.—It is essential to use mains primary types with TV receivers having series connected heaters.

RESISTORS. Preferred values. 20% 10 ohms to 10 meg, 1/2W 4d., 3/4W 4d., 1W 6d., 1 1/2W 8d., 2W 1/- HIGH STABILITY. 1/2W 1/6, 2/-, All preferred values 100 ohms to 10 meg. Ditto 10% 6d. each

WIRE-WOUND RESISTORS

5 watt } 1/3
10 watt } 25 ohms-10,000 ohms } 1/6
15 watt } 2/-

15,000 ohms-50,000 ohms. 5W, 1/9; 10W, 2/3

WIRE-WOUND POTS

3W Lab. Colvern, etc. Pre-set min. TV type. Standard size Pots., 2 1/2" Knurled slotted knob. Spindle high grade. All values, 100 ohms to 50K. 5/6; 100K, 6/6

Ditto Carbon Track 50K W/W EXT. SPEAKER to 2 Meg, 3/-

O/P TRANSFORMERS.

Heavy duty 50mA, 4/6. Multi-ratio push-pull, 7/6. Miniature 3V4, etc., 4/6. Small pentode 4/6. Hygrade push-pull 7 watts, 15/6 L.F. CHOKES 15/10H 60/65mA, 5/-; 25/20H, 100/120mA, 11/6; 20/15H, 120/150mA, 12/6; 5H, 250mA, 15/- MAINS TRANS. 350-0-350, 80mA, 6.3V tapped 4V 4A 5V tapped 4V 2A, ditto 250-0-250 80mA, etc., 22/6

CRYSTAL MIKE INSERT by Aco

Precision engineered. Size only 1 1/8" x 3/16". Bargain. Price 6/6 No transformer required

HEATER TRANS.

Tapped 200/250V 6.3V 1 1/4, 7/6 ALADDIN FORMERS and cores. 1/2" 8d., 3/8" 10d. 0.3" FORMERS 5937/8 and cans TV1/2. 2" sq. x 2 1/2" and 3" sq. x 1 3/8", 2/- complete with cores

SLOW MOTION DRIVES.

Epicyclic ratio 6-1, 2/3 TYANA. Midget Soldering Iron. 200/220V or 230/250V, 16/9. SOLON MIDGET IRON, 25W, 24/- MAINS DROPPERS. 3" x 1 1/2". Three adj. sliders. 0.3A 750 ohms, 4/3; 0.2A 1,000 ohms, 4/3

LINE CORD.

0.3A 60 ohms per foot, 0.2A 100 ohms per foot, 2-way, 6d. per foot; 3-way 7d. per foot

MIKE TRANSF.

50:1, 3/9; 100:1 Potted 10/6

LOUDSPEAKERS.

P.M. 3 ohm. 2 1/2" square, 17/6 5" R.A. 17/6, 7" x 4" Goodmans 21/-, 3 1/2" sq. Elac, 21/-, 8" Plessey 19/6, 6 1/2" Goodmans 18/6, 10" R.A. 30/-, 12" Plessey 30/-, 8" M.E. 2.5K field tapped, o.p. transformer 24/6, 15 ohm Plessey 10W 12" with tweeter 97/6

CRYSTAL DIODES.

G.E.C. 2/-; GEX34 4/6

40 CIRCUITS FOR GERMANIUM DIODES, 3/-

CRYSTAL SET, complete kit 12/6.

Construction book 1/- TUNING AND REACTION COND. 100pF, 300pF, 500pF, 3/6 each, solid dielectric

H.R. HEADPHONES

4,000 ohms, brand new, 16/6 per

SWITCH CLEANER Fluid,

squirt spout, 4/3 tin

TWIN GANG CONDENSERS.

365pF, miniature. 1 3/8" x 1 1/2" x 1 1/2", 10/- 0.0005 standard with trimmers, 9/-; less trimmers, 8/- Midget 7/6; 50pF single, 2/6

SUPERHET COIL PACK 27/6

Miniature size 2 1/2" x 2 1/2" x 1 1/2". High Q dust coated coils. Short, Med., Long. Gram. switching with connection diagram and circuit. 465 kc/s i.f.

Written guarantee with every purchase

RADIO COMPONENTS

Buses 133 or 68 pass door. S.R. Stn. Sejhurst, 48-hour Post

Aluminium Chassis. 18 s.w.g. Plain, undrilled, with 4 sides, riveted corners and lattice fixing holes, with 2 1/2" sides. 7" x 4", 4/6; 9" x 6", 5/9; 11" x 7" 6/9; 13" x 9", 8/6; 14" x 11", 10/6; 15" x 14", 12/6; 18" x 16" x 3", 16/6

Volume Controls

Midget size
Long spindles. Guaranteed 1 year. All values 10,000 ohms to 2 Meg. No Sw. S.P.Sw. D.P.Sw.
3/- 4/- 4/9
Linear or Log Tracks

80 Ω Coaxial cable

Semi-air spaced Polythene insulated 1/2" dia. stranded core. Ideal Band III 9d. yd. Losses cut 50%.

FRINGE QUALITY

Air-spaced Coaxial 1/6 yd

Coaxial Plugs 1/- Double Socket 1/3
Sockets 1/- Outlet Boxes 4/6

Balanced Twin Feeder per yd. 6d. 80Ω or 300Ω
Twin Screened Balanced Feeder, 1/- yd. 80 ohms
Trimmers. Ceramic, 30, 50, 70pF, 9d.; 100pF, 150pF, 1/3; 250pF, 1/6; 600pF, 750pF, 1/9. Philips 1/- each

BLACK CRACKLE PAINT. Air drying. 3/- tin
P.V.C. CONN. WIRE. 10 colours, single or stranded, 2d. yd. Sleaving 1, 2 mm 2d., 2, 3 mm 3d., 6 mm 5d. yd

5" **RADIO SCREWDRIVERS.** 6d. each
NEON MAINS TESTER SCREWDRIVERS. 5/3
MULTICORE SOLDER. 60/40, 18 s.w.g., 3d., 16 s.w.g., 4d. yd.; 1lb 2/6

Sentencer Rectifiers. E.H.T. Type Fly-back. Voltages: K3/25 2kV, 5/-; K3/40 3.2kV, 7/-; K3/45 3.6kV, 7/6; K3/50V 4kV, 8/-; K3/100 8kV, 14/6

50 cps voltage 30% of above ratings

Mains Type RM1, 125V 60mA, 5/-; RM2 100mA, 6/-; RM3 120mA, 8/-; RM4 250V 275mA, 16/-; RM5, 20/-
Miniature Contact Cooled Rectifiers. 250V 50mA, 8/6; 250V 85mA, 9/6. Selenium Rect. 300V 85mA, 7/6
Coils. Wearite "P" type, 3/- each. Osmor Midget "Q" type adj. dust core, from 4/- each. All ranges
Teletron. L & Med. T.R.F., with reaction, 3/6
Ferrite Rod Aerials. M.W., 8/9; M. & L., 12/6
T.R.F. Coils A/HF, 7/- pair. H.F. Chokes, 2/6

HANDY VOLTMETERS

2" Twin Range 0-25V, 0-250V d.c. with leads and leather case, 12/6 each

Condensers. New stock. 0.001 μF 7kV T.C.C., 5/6; ditto 20kV, 9/6; 100pF to 500pF Micas, 6d.; Tubular 500V 0.001 to 0.01 μF, 9d.; 0.05, 0.1, 1/-; 0.25, 1/6; 0.5, 1/9; 0.1/350V, 9d.; 0.1/600V, 1/3; 0.1/2,000V, 3/6
Ceramic Condensers. 500V 0.3pF to 0.01 μF, 10d.
Silver Mica. 10% 5pF to 500pF, 1/-; 60pF to 3,000pF, 1/3; Close tolerance (plus or minus 1pF), 1.5pF to 47pF, 1/6; ditto 1% 50pF to 815pF, 1/9; 1,000pF to 5,000pF, 2/-
NEW ELECTROLYTICS. FAMOUS MAKES

TUBULAR	TUBULAR	CAN TYPES
1/350V 2/-	100/25V 3/-	8+16/450V 5/-
2/450V 2/3	8+8/500V 6/-	16+16/500V 6/-
4/450V 2/-	16+16/500V 6/-	6,000μF 6V 6/6
8/450V 2/3	CAN TYPES	
8/500V 2/9	Clips 3d.	32+32/350V 4/6
16/450V 3/6	16/450V 3/6	64+120/275V 7/6
16/500V 4/-	32/350V 4/-	60+100/350V 11/6
32/450V 5/6	64/350V 5/6	100+200/275V 10/6
25/25V 1/9	100/275V 5/6	
50/25V 1/9	50+50/350V 7/-	1,000+1,000/6V
50/50V 2/-	500/12V 3/-	

Full Wave Bridge Selenium Rectifiers. 2, 6 or 12V 1 1/2A, 8/9; 2A, 11/3; 4A, 17/6

Charger Transformers. Tapped input 200/250V for charging at 2, 6 or 12V 1 1/2A, 15/6; 2A, 17/6; 4A, 22/6

12/6 PURETONE RECORDING TAPE

1,200ft on standard fitting 7" metal reels.
Spare reels 5" metal, 1/6; 7" metal, 2/3

FERROVOICE 1,200ft Plastic Tape, 25/-

CHAMPION (VHF) FM TUNER

88 to 96 Mc/s

5 MULLARD VALVES and SUPERHET TUNING HEART

Maroon and cream receiver styled cabinet 6" x 12" x 6". Features: This is a self-powered 200/250V a.c. VHF (FM) Adaptor with operating and servicing data, and a screened lead for connection to pick-up sockets of any radio, radiogram or amplifier.

Brand new with 12 months guarantee. List price 16 gns. Our price 10 gns., carr. 4/6
Terms: Deposit £6 and 6 monthly payments of £1

BBC Beginners 1 valve radio kit in stock

JASON FM TUNER COIL SET. 26/- H.F. coil, aerial coil, oscillator coil, two i.f. transformers 10.7 Mc/s, detector transformer and heater choke. Circuit and component book using four 6AM6, 2/-, J.B. Chassis and dial, 19/6. Complete kit, £5.18.6. With Jason superior calibrated dial. £6.15.0.

Wavechange Switches. 2 p 2-way, 3 p 2-way, short spindle, 2/6; 5 p 4-way 2 wafer, long spindle, 6/6; 2 p 6-way, 4 p 2-way, 4 p 3-way, long spindle, 3/6; 3 p 4-way, 1 p 12-way, long spindle, 3/6; Wave change "MAKITS." 1 wafer, 8/6; 2 wafer, 12/6; 3 wafer, 16/-; 4 wafer, 19/6; 5 wafer, 23/-; 6 wafer, 26/6
Toggle Switches, s.p. 2/-, d.p. 3/6, d.p.d.t. 4/-
Morse Keys, good quality, 2/6. Buzzers 3/6

Knobs, Gold Engraved. Walnut or Ivory. 1 1/2" diam., 1/6 each. "Focus," "Contrast," "Brilliance," "Brilliance-On/Off," "On-Off," "Volume," "Volt-On/Off," "Tone," "Tuning," "Treble," "Bass," "Wave-change," "Radio-Gram," "S.M.L.-Gram," "Record-Play," "Brightness." Ditto, not engraved, 1/-

Valveholders. Pax. int. oct., 4d. EF50, EA50, 6d. B12A, CRT, 1/3. Eng. and Amer. 4, 5, 6, 7 and 9 pin, 1/-
MOULDED Mazda and int. oct., 6d., B7G, B8A, B8G, B9A, 9d. B7G with can, 1/6. VCR97, 2/6. B9A with can, 2/6. Ceramic, EF50, B7G, B9A int. oct., 1/-, B7G with can, 1/9; B9A with can, 2/9

Speaker Fret. Gold cloth, 17" x 25", 5/-; 25" x 35", 10/-; Expanded metal, silver, 15 1/2" x 9 1/2", 2/- each;

Tygan. 4 1/2" wide, 10/- ft; 2" 3/4" wide, 5/- ft.
TV Fault Finding. Data Publications, 5/- each
Radio Valve Guide. Books 1, 2 or 3, 5/- each

All Boxed VALVES New & Guaranteed

1R5	8/6	6K8	8/6	EABC80	8/6	EZB1	11/6
1S5	8/6	6L6	10/6	EB91	6/6	E148	1/6
1T4	8/6	6Q7	10/6	EBC33	8/6	HABC80	12/6
3S4	8/6	6SA7	7/6	EBF41	10/6	HVR2A	7/6
3V4	8/6	6SN7	8/6	EBF80	8/6	MUI4	10/6
5U4	8/6	6V6G	7/6	ECC84	12/6	P61	6/6
5Y3	8/6	6V6GT	8/6	ECCF80	10/6	PCF84	12/6
5Z4	10/6	6X4	7/6	ECF82	10/6	PCF80	10/6
6AM6	8/6	6X5	7/6	ECH42	10/6	PCF82	10/6
6B8	5/6	757	8/6	ECL80	8/6	PCL82	10/6
6BE6	7/6	12A6	7/6	ECL82	12/6	PEN25	6/6
6BH6	10/6	12AH8	10/6	EF39	7/6	PL82	10/6
6BW6	8/6	12AT7	10/6	EF41	10/6	PY80	10/6
6BW7	8/6	12AU7	10/6	EF50	5/6	PY81	10/6
6CH6	10/6	12AX7	10/6	Equip.		PY82	10/6
6D6	7/6	12BE6	10/6	EF50	8/6	SP61	5/6
6F6	7/6	12BH7	10/6	Sylv.		UBC41	10/6
6H6	3/6	12K7	8/6	EF80	10/6	UCH42	10/6
6J5	6/6	12Q7	8/6	EF92	5/6	UF41	10/6
6J6	7/6	35Z4	10/6	EL32	5/6	UL41	10/6
6J7	8/6	80	8/6	EL84	10/6	UY41	10/6
6K6	6/6	95A	1/6	EY51	11/6	U22	10/6
6K7	5/6	EA50	1/6	EZ40	10/6	X79	10/6

337 WHITEHORSE ROAD WEST CROYDON

Telephone THO 6655 Catalogue 6d.

Service. P. & P. 1/-, over £2 post free, C.O.D. 1/6 (Export C.W.O. post extra, no H.P.) OPEN ALL DAY (Wed. 1 p.m.)

NT SPECIALISTS

TURRET TUNER

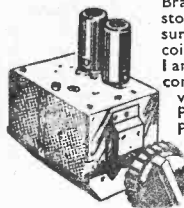

Brand new stock, not surplus, with coils for Bands I and III, complete with valves PCC84 and PCF80—L.F.

Output 33/38 Mc/s with circuit diagram

79/6. With knobs 3/6 extra, post and ins. 2/6

MORGANITE POTENTIOMETERS

Single and 2-gang types available, standard size with good length spindle, all new and boxed

Gang type 3/- each. Values available: 5K+5K, 100K+100K, 1/2 meg + 1/2 meg. Single types 1/- each. Values available: 10K, 25K, 50K, 100K, 250K, 1 meg, 2 meg.

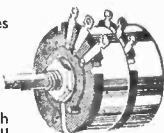

TRANSISTORS

A good range of transistor parts, miniature transformers, electrolytics, etc., available at all branches.

Red Spot and Audio 10/-
Blue Spot 1.6 Mc/s 15/-
White Spot 2.5 Mc/s 20/-



CERAMIC SWITCHES

By one of our best makers, 3 pole, 3 way, 2/6 each, also standard type switches 12 pole, 2 way, 1/3 each, 6 pole, 3 way, 1/3 each, 2 pole, 6 way, 1/6 each, 6 pole, 4 way, 2/6 ea.

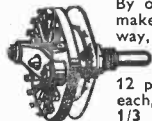

WATERPROOF HEATER WIRE

Suitable for making heated carpets, blankets, foot muffs, etc., also for warming seed boxes, fish tanks, etc. Price 1/- per yd plus 1/- post if under 40 yds

THERMOSTATS



Useful for the control of appliances. Adjustable to operate over the

temperature range 50-550° F. 1 1/2 3/6, 5A 8/6, 2A QMB 5/6, 15A QMB 15/-, 15A wall mounting type 19/6

17" Unit Built TV Chassis

Complete with tube and speaker, delivered to you for £8 deposit and weekly payments of 25/- for 35 weeks or £47 cash with order. Non-callers add 10/- carriage and insurance.

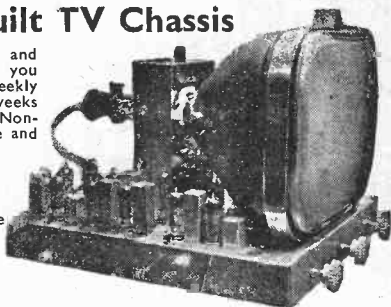

MOST UP-TO-DATE TELEVISOR for home construction, can be completed in one evening (only 24 solder joints to make). When finished equal to any factory made set. Note these features:

- ★ No technical knowledge required
- ★ All miniature valves and metal rect.
- ★ Vision and sound interference suppression
- ★ 12 channel turret tuner
- ★ Ferro core e.h.t. scan coils

If required less tube and speaker, price £29.10.0 plus 10/- carriage and insurance. FULL INFORMATION AND CONSTRUCTIONAL DATA AVAILABLE SEPARATELY PRICE 3/6

FLUORESCENT LIGHTS

These are complete fluorescent lighting fittings. Built in ballast and starters—stove enamelled white and ready to work.

Single 40. 4' 3" long, uses a 40 watt tube.

Twin 20. Uses two 20-watt standard tubes. Price 39/6 each, with tubes. Carriage and ins. up to 150 miles 5/6, up to 250 miles 7/6

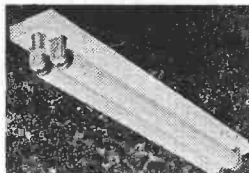

Entirely Redesigned

A.C./D.C. MULTIMETER KIT

Measures a.c./d.c. volts and ohms. All the essential parts including metal case, 2" moving coil meter, selected resistors, wire for shunts, range selector, switches, calibrated scale and full instructions, price 19/6 plus 1/9 post and insurance.



SPEAKER BARGAIN

12" Hi-fidelity loudspeaker. High flux. Permanent magnet type with standard 3 ohm speech coil. Will handle up to 12 watts. Brand new by famous maker. Price 32/6 plus 3/6 post and insurance.

All the parts for making transistorised Enlarging or Process Timer with constructional details, £2.10.0

The "CRISPIAN" PORTABLE RADIO

A 4-valve portable: Ferrite rod aerials, low consumption valves, a.v.c., ready-built and aligned chassis if required, beautiful two-tone cabinet. Guaranteed results on long and medium waves anywhere. All parts, including speaker and cabinet. If all ordered together the price is £7.15.0 complete, post and insurance 3/6, ready-built chassis 30/- extra. Instruction booklet free with parts or available separately, price 1/6



ELECTRONIC PRECISION EQUIPMENT LTD

POST ORDERS SHOULD BE ADDRESSED TO DEPT. 34 66 GROVE ROAD EASTBOURNE

Personal shoppers, however, can call at

266 LONDON ROAD CROYDON
Telephone CROydon 6558 Half-day Wednesday

152/3 FLEET STREET EC4
Telephone FLEet 2833 Half-day Saturday

42/46 Windmill Hill Ruislip Middlesex
Telephone RUISlip 5780 Half-day Wednesday

29 Stroud Green Road Finsbury Park N4
Telephone ARChway 1049 Half-day Thursday

EMI

"HIS MASTER'S VOICE"

MARCONIPHONE · COLUMBIA

Announce

NEW PRACTICAL WAY OF LEARNING AT HOME

NEW—completely up-to-date methods of giving instruction in a wide range of technical subjects specially designed and arranged for self-study at home under the skilled guidance of our teaching staff.

NEW—experimental outfits and lesson manuals are despatched on enrolment and remain the student's property. A tutor is allotted to each student for personal and individual tuition throughout the course.

Radio and television courses, with which specially prepared components are supplied, teach the basic electronic circuits (amplifiers, oscillators, detectors, etc.) and lead, by easy stages, to the complete design and servicing of modern Radio and T/V equipments.

If you are studying for an examination, wanting a new hobby or interest, commencing a career in industry or running your own full-time or part-time business, these practical courses are ideal and may be yours for moderate cost. Send off the coupon to-day for a free Brochure giving full details. There is no obligation whatsoever.

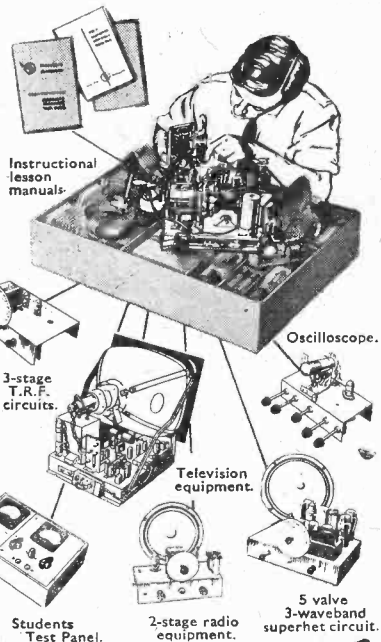

Courses with Equipment

- RADIO · SHORT WAVE RADIO
- TELEVISION · MECHANICS
- CHEMISTRY · PHOTOGRAPHY
- ELECTRICITY · CARPENTRY
- ELECTRICAL WIRING · 'HI-FI'
- DRAUGHTSMANSHIP · ART, etc.

E.M.I. Factories
at Hayes,
England.



EMI INSTITUTES

Fill in for **FREE BROCHURE**

E.M.I. INSTITUTES, Dept. 179X, London, W.4.

Name Age
(If under 21)

Address

I am interested in the following subject(s) with/
without equipment.....
(We shall not worry you with personal visits)

BLOCK
CAPS
PLEASE

IC107
JAN/58



The only Home Study College run by a World-wide industrial organisation

PREMIER RADIO COMPANY

B. H. MORRIS & CO. (RADIO) LTD
(Dept. R.C.1) 207 EDGWARE ROAD LONDON W2

Telephone
AMB 4033
PAD 3271

Open till
6 p.m. Saturday

Build the New "MAYFAIR" Televisor

which gives complete SAFETY to the constructor!

These Televisors use a double wound mains transformer which gives you complete safety from contact with the mains supply when handling the chassis or controls.

★ B.B.C. & I.T.A. DESIGN ★
WITH NEW TURRET TUNER

MAY BE BUILT FOR **£33.7.11** PLUS COST OF C.R.T.
Build in 5 easy stages. Full construction details available. Instruction Book 3/6 post free

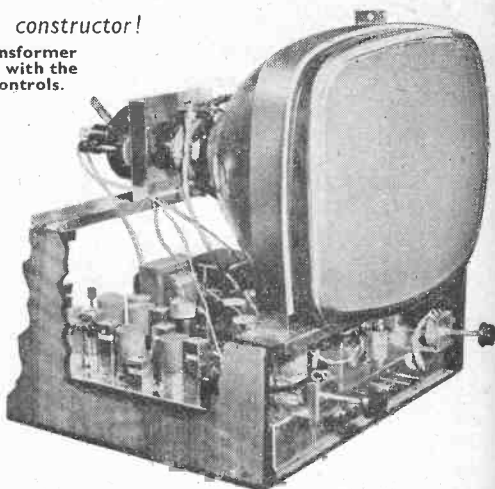

AT LAST!





PREMIER RADIO CO
have opened a branch in the
middle of the West End at
23 TOTTENHAM COURT RD
The best Hi-Fi Showroom in the district
Telephone MUSEum 3451

'Q' - Fidelity FM

Reliable FM Tuners of High Performance for Hi-Fi amplifiers or as add-on units for existing radios or radiograms. Fullest information supplied.

Model 1. The "Mini-Magic." Economy is the watchword of this clever unit which is achieved without sacrifice of performance or reliability. 5 gns. incl. P.T. Kit **£4 10s.**

Model 2. Simple switch-tuning with automatic frequency control. A high-quality, stable and completely drift-free unit. Kit or separate components. Size $4\frac{1}{2}'' \times 4\frac{1}{2}'' \times 5\frac{1}{2}''$.

<p>High "Q" Coils 4/- EACH Iron dust cores. Clip in fixing. EXTREMELY SMALL. AMAZING EFFICIENCY For Superhet T.R.F. or Transistor operation.</p> 	<p>All coils for Collaro Tape Transistor pre-amp. BIAS OSC. Coil Type 7/6</p> 	<p>STATION SEPARATOR HOME - LIGHT - THIRD - LUX ETC. 10/6 Not a guaranteed cure but — A positive answer to selectivity problem.</p> 	<p>STOP! T.V. Patterning 10/- An easily fitted—Simple Remedy</p> 	<p>I.T.A. Converter To fit inside T.V. complete £4 65/- KIT Very efficient. Can be built in an evening. State Channels</p> 
---	---	---	---	--

OSMOR COILS FREE!
ARE BEST FOR
Selectivity & Performance

OSMOR

Send 1/- (stamps) for fully descriptive literature including OSMOR DESIGNS—5-valve Superhet, Miniature ditto, Battery and Battery/Mains Receiver, Mains T.R.F. Superhet and T.R.F. Feeders. Band III Converters, Wiring Diagrams, Chassis Templates, Coils and Coilpack information and price lists and information on circuits in Wireless World, Practical Wireless, The Radio Constructor

(Dept. RC18) 418 BRIGHTON ROAD SOUTH CROYDON . SURREY Telephone CROydon 5148/9

Wanted!

QUALIFIED MEN AND WOMEN

Industry and Commerce offer their best posts to those with the qualifications — appointments that will bring personal satisfaction, good money, status and security. As part of a modern industrial organisation, we have skilled knowledge of what is required and the best means of training personnel for its present day and future requirements. We specialise also in teaching for hobbies, new interests or part-time occupations in any of the subjects listed below. Write to us to-day for further information. There is no obligation of any kind.

PERSONAL & INDIVIDUAL TRAINING IN —

- | | | |
|---------------------------------------|-------------------------------------|--------------------------------|
| Accountancy | Electronics | Production |
| Advertising | Electronic | Planning |
| Aeronautical Eng. | Draughtsmanship | Radar |
| A.R.B. Licences | Eng. Drawing | Radio |
| Art (Fashion, Illustrating, Humorous) | Export | Radio Amateur's (C&G) Licence |
| Automobile Eng. | General Certificate of Education | Radio & Television Servicing |
| Banking | Heating & Ventilating Eng. | Refrigeration |
| Book-keeping | High Speed | Sales Management |
| Building | Oil Engines | Sanitary Eng. |
| Business Management | Industrial Admin. Jig & Tool Design | Salesmanship |
| Carpentry | Journalism | Secretaryship |
| Chemistry | Languages | Shorthand & Typing |
| City & Guilds Exams | Management | Short Story Writing |
| Civil Service | Maintenance Eng. | Short Wave Radio |
| Commercial Subjects | Mathematics | Sound Recording & Reproduction |
| Commercial Art & Drawing | M.C.A. Licences | Telecommunications |
| Customs Officer | Mechanical Eng. | Television Time & Motion Study |
| Draughtsmanship | Metallurgy | Tracing |
| Economics | Motor Eng. | Welding |
| Electrical Eng. | Painting & Decorating | Workshop Practice |
| Electrical Installations | Photography | Works M'gement and many others |
| | P.M.G. Cert. | |
| | Police | |
| | Production Eng. | |

OUR BACKGROUND!



Part of The E.M.I. Factories at Hayes, England, occupying over 150 acres.

Also courses for GENERAL CERTIFICATE OF EDUCATION, A.M.I.H.&V.E., A.M.S.E., A.M.Brit.I.R.E., A.M.I.Mech.E., A.M.I.E.D., A.M.I.M.I., A.F.R.Ae.S., A.M.I.P.E., A.M.I.I.A., A.C.C.A., A.C.I.S., A.C.C.S., A.C.W.A., City & Guilds Examinations, R.T.E.B.Serv. Cert, R.S.A. Certificates, etc.

The only Home Study College
operated by a world-wide
manufacturing organisation

NEW! Courses with PRACTICAL EQUIPMENT

IN RADIO · TELEVISION · MECHANICS · CHEMISTRY
ELECTRICITY · DRAUGHTSMANSHIP
PHOTOGRAPHY, ETC., ETC.

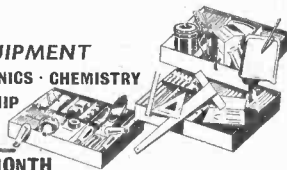

COURSES FROM 15/- PER MONTH

EMI

INSTITUTES

POST THIS TODAY

E.M.I. INSTITUTES, Dept. 179K, London, W.4

NAME _____ AGE _____
(if under 21)

ADDRESS _____
I am interested in the following subject(s) with/without equipment

JAN/58

(We shall not worry you with personal visits).



BLOCK
CAPS
PLEASE

IC 92

The only Home Study College run by a World-wide industrial organisation

JASON "Mercury"

SWITCHED FM TUNER

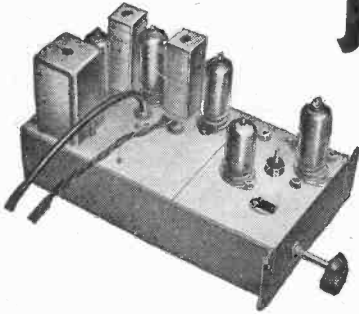

An Easy-to-Build All-British Design by JASON

- All parts including assembled Front End with 2 valves (we regret we are unable to supply remaining valves) come to

£9.0.0

- Switch Tuned Front End only with 2 valves, ready wired, tested and aligned.

£6.5.0 Inc. £1.15.0 P/Tax

The success of Jason Switch Tuned FM Units is already well known. It is due largely to their stability and all-round good design. Now you can build one for yourself with this authentic Jason 5-valve design in which the Switch Tuned Front End comes to you assembled and aligned ready for building in, and with station-marked scale plate.

- **POWER PACK** suitable for use with above. Parts to come **£2. 1. 9**

- Please send S.A.E. or complete list of components and prices

JASON MOTOR & ELECTRONIC CO 328 CRICKLEWOOD LANE LONDON NW2
SPEEdwell 7050

G2AK • QUALITY AND SERVICE • G2AK

SPECIAL OFFER!

**AMERICAN OCTAL BASED
1,000 kc/s PRECISION
XTALS**

Replacements for BC221
30/- post free

Very limited quantity available—
DON'T BE TOO LATE

ABSORPTION WAVEMETERS. 3.00 to 35.00 Mc/s in 3 switched bands, 3.5, 7, 14, 21 and 28 Mc/s. Ham bands marked on scale. Complete with indicator bulb. A must for any Ham Shack. Only 17/6 each post free

Full range of Denco, Repanco and Eddystone coils and components available. Also most comprehensive range of Hi-Fi equipment in the Midlands including Quad, R.C.A., W.B. Leak, Rogers, etc.

HEADPHONES, H.R. type. 4,000 ohms. Very sensitive, only 12/6 pair, post 1/6. **C.L.R. type** (low res.) 8/6, post 1/6

AMERICAN BREAST MIKES. Swivel head, push-to-talk and lock-on switch; excellent job, only 12/6, post 1/6

BRITISH BREAST MIKES (carbon). Ideal for mobiles, 7/6 p.p. 1/6

PLUG-IN NOISE LIMITERS. 3-position limiting. No rewiring. Best with h.r. 'phones. Only 8/6, p. & p. 1/6

SEMI-MIDGET I.F. TRANSFORMERS. 10.7 Mc/s and 465 kc/s (can be used as 10.7 Mc/s and 465 kc/s only), 9/11 per pair, postage 9d.

TWIN FEEDER. 300 ohm twin ribbon feeder, similar K25, 6d. per yard. K35B Telcon (round), 1/6 per yard. Post on above feeder and cable, 1/6 any length

PANL HOME CRACKLE. Black, 3/- tin, postage and packing 8d.

COLLINS MODULATION TRANSFORMERS. P.P. 807s 20Vv audio to parr. 807s. Beautiful job. 12/6 each carr. paid

REPANCO TRANSEVEN

Portable, using 7 transistors. Complete kit of parts including wiring plan and instructions. **NOW AVAILABLE FROM STOCK** Send for building instructions and priced parts list, 1/6

RACK MOUNTING PANELS. 19" x 5½", 7", 8½" or 10½" black crackle finish, 5/9, 6/6, 7/6, 9/- respectively, postage and packing 2/-

AERIAL EQUIPMENT

COPPER WIRE 14g. h.d.; 140' 17/-; 70' 8/6; 7/25 stranded: 140' 10/-, 70' 5/-, Plus 2/- p. & p.

RIBBED GLASS INSULATORS, 3" 1/6 each or 6 for 7/6. Postage and packing 1/6

HEAVY DUTY SHROUDED CHOKES. 10H, 150mA, 80 ohms. Only 10/-, p. and p. 2/6

PLEASE PRINT YOUR NAME AND ADDRESS

CHAS. H. YOUNG LTD

Dept. 'R', 110 DALE END, BIRMINGHAM
Telephone Central 1635

CLYNE RADIO LTD



"KITS OF PARTS TO BUILD YOURSELF"

We are THE experts in this field and carry the most comprehensive stocks of kits of parts in the country. Itemised price lists and full details will be found in our 109-page comprehensive catalogue. This invaluable publication, well illustrated and containing full description of all items stocked by us, together with a wealth of useful information, is only 2/- post free.

ACOS CRYSTAL MIKE INSERTS. Ex-equipment but new condition. Ideal for Tape Recorders etc. 4/6 plus p. & p. 9d.

NEW PLASTIC RECORDING TAPE. 1,200 ft on plastic spool. 21/-, plus 1/6 p. & p. 3 spools for 63/- post free

VALVES. We have perhaps the most up-to-date valve stocks in the trade. A stamp will bring complete list of brand new imported valve types, fully guaranteed, P.T. paid. Also all usual surplus types available such as 6V6GT, 6X5GT, etc.

CONSTRUCTORS NOTE. Radio Data Books available, i.e. Valve Guide, Colour code, etc. Send stamp for list.

FM POWER PACK KIT
(as described in this issue). Complete kit 37/6 plus p. & p. 1/6, or 52/6 for ready assembled unit

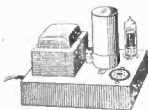

METERS. Ex-W.D. Meters of all types in stock. Send stamp for list.

UNIVERSAL AVO MINOR (few only). 16 ranges: d.c. 5V, 25V, 100V, 250V, 500V, 2.5mA, 5mA, 25mA, 100mA, 500mA, 0-20,000 ohms; a.c. 5V, 100V, 250V, 500V. Complete with test leads, self-contained battery.

Overall size 4 1/4" x 3 3/4" x 1 1/4". Scale length approx. 3". Ex-W.D. but brand new and unused. £7.10.0 only

TAYLOR "MONTROSE" METER. A most useful pocket sized a.c./d.c. multimeter. This compact instrument covers eight a.c./d.c. ranges: 3A, 300mA, 30mA, 6V, 30V, 150V, 300V and circuit test. Scale length approx. 2". Dimensions (overall) 3 3/4" x 3" x 1 1/4". Brand new, fully guaranteed, only 63/-, plus 1/- p. & p.

★ ALL MAIL ORDERS AND CORRESPONDENCE — CALLERS WELCOME

18 TOTTENHAM COURT ROAD
LONDON W1 MUS 5929/0095

Also at

★162 HOLLOWAY ROAD · LONDON N7
NOR 6295/6/7

AMERICAN SUPER-LIGHTWEIGHT HEADPHONES. Magnetic type, fitted with rubber earmoulds. Impedance 50 ohms. Brand new 15/- pr, plus 1/- p. & p.

ROTHERMEL LIGHTWEIGHT CRYSTAL HEADPHONES. Limited stocks of these well-known headphones are available once again. Suitable for all purposes. Only 21/- pair plus 1/- p. & p.

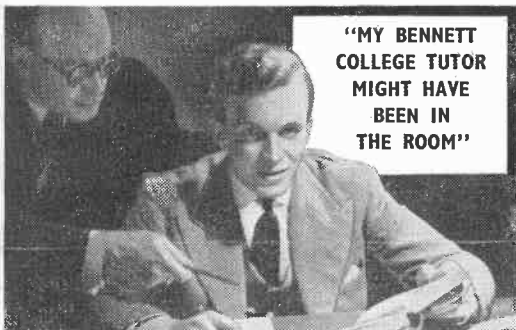

"MY BENNETT COLLEGE TUTOR MIGHT HAVE BEEN IN THE ROOM"

PERSONAL POSTAL TUITION

Every Bennett College student enjoys this friendly, intimate coaching right through his Course. A few of the Courses are listed opposite. Tell us your subject. We will send you The Bennett College Prospectus and the famous FREE book "Train your mind to SUCCESS." This will show you how you can advance to a better, finer future by Personal Postal Tuition. Fill in and post the coupon today.

WHAT CAREER DO YOU WANT?

- | | | |
|-----------------|-------------------|-----------------|
| Architecture | Plumbing | English |
| Building | Quantity Sur- | Geography |
| Carpentry | veying | Journalism |
| Commercial Art | Radio Engineering | Languages |
| Diesel Engines | Sanitary Science | Mathematics |
| Draughtsmanship | Surveying | Modern Business |
| Electrical Eng. | Telecommuni- | Methods |
| Electric Wiring | cations | Police Subjects |
| Forestry | Television | Salesmanship |
| Locomotive Eng. | Wireless Tele- | Shorthand |
| Machine Design | graphy and | Short Story |
| Mechanical Eng. | Telephony | Writing |
| Motor Eng. | Book-keeping | and many others |

OR WHY NOT OBTAIN A QUALIFICATION?

- | | | | |
|---------------|-----------------|------------|------------|
| A.M.I.C.E. | A.M.I.Struct.E. | A.A.C.C.A. | A.C.C.S. |
| A.M.I.Mech.E. | A.M.I.Mun.E. | A.C.W.A. | A.R.I.C.S. |
| A.R.I.B.A. | A.M.S.E. | A.C.I.S. | A.A.I. |
- GEN. CERT. of EDUCATION & R.S.A. Exams.

TO THE FAMOUS

BENNETT COLLEGE

Dept. (A 162PT) SHEFFIELD

Please send me the Prospectus on..... and my free copy of "Train your mind to SUCCESS."

NAME

ADDRESS

TOWN

AGE (if under 21)

Please write in BLOCK letters

Post this coupon NOW!

◀ ▶ ▶ ▶ **REPANCO** ▶ ▶ ▶ ▶

HIGH GAIN COILS and QUALITY COMPONENTS for the constructor

TRANSISTOR COMPONENTS

- FERRITE SLAB AERIAL TYPE FS2.** A new super-sensitive aerial, Long and Medium Wave, specially designed for transistor portable receivers. Complete with fixing brackets. Length 5½" 13/6
- COMBINED OSCILLATOR AND 1st I.F. TRANSFORMER TYPE OT1** (315 kc/s), fully screened, 1½" x 1½" x 1½" 11/6
- 2nd I.F. TRANSFORMER TYPE TT2** (315 kc/s), 1" x ⅝" dia. 5/-
- 3rd I.F. TRANSFORMER TYPE TT3** (315 kc/s), 1" x ⅝" dia. 5/-
- PUSH-PULL INTER-STAGE TRANSFORMER TYPE TT4.** Ratio 1:1 ct. Stack 1½" x 1-⅞" x ⅞" 8/6
- PUSH-PULL OUTPUT TRANSFORMER TYPE TT5.** Ratio 15:1 ct. Stack 1½" x 1-⅞" x ⅞" 8/-

MINIATURE RANGE—For pocket receivers

- FERRITE SLAB AERIAL TYPE FS3.** Medium Wave only. With fixing grommets. Size 3" x ¾" x ⅜" 7/6
- OSCILLATOR COIL TYPE XO8.** Medium Wave only. Overall size ½" dia. x 1". Enclosed in Ferrite pots 5/-
- I.F. TRANSFORMER TYPE XT6.** Suitable for 1st and 2nd I.F. 455 kc/s. Size ½" sq. x 1½" ... 10/-
- I.F. TRANSFORMER TYPE XT7.** Designed for 3rd I.F.T. or detector I.F.T. 455 kc/s. Size as XT6 10/-
- PUSH-PULL INTERSTAGE TRANSFORMER TYPE TT9.** Ratio 1:1 ct. Radiometal Core. Size ¾" x ⅝" x 1½" 12/6
- PUSH-PULL OUTPUT TRANSFORMER TYPE TT10.** Ratio 8-1 ct. Matched to 3 ohm speaker. Size as TT9 12/6
- Practical and Theoretical circuits enclosed with each Repanco Transistor Component*

HIGH GAIN COILS

- | | | |
|--|-----|--|
| <p>Dual-range Miniature Crystal Set Coil with circuit, type DRX1 2/6</p> <p>Dual-range Coil with Reaction. With 2 mains, 2 battery and Transistor Circuit type DRR2 4/-</p> <p>Ferrite Rod Aerial, Long and Medium Wave. With fixing brackets, type FR1... 12/5</p> | } { | <p>Matched pair TRF Dual-range Coils with Reaction. With mains, battery and feeder unit circuits, type DRM3 pr. 8/-</p> <p>Pair Dual-range Superhet Coils. With mains and battery circuits, type SH4 pr. 8/-</p> <p>Miniature I.F. Transformers, pre-aligned, 465 kc/s 1½" x 1½" x 1½", type MSE ... 12/6</p> |
|--|-----|--|

REPANCO EASY-TO-BUILD RECEIVERS

Constructors' Envelopes of easy wiring plans, instructions and detailed price lists of components

- THE HIWAYMAN** Envelope 1/6 (post 3d.)
Four-valve superhet Dual-range Portable using Ferrite Rod Aerial
- REPANCO ONE-VALVE** Envelope 9d. (post 3d.)
Beginner's Dual-range Radio Set for use with headphones
- REPANCO FM TUNER UNIT** Envelope 1/6 (post 3d.)
Using 4 EF91, 1 EB91, 1 EM8J Valves, Ratio Detector
- REPANCO "THREE DEE"** Envelope 9d. (post 3d.)
Dual-range Transistor Radio using 3 Transistors and Crystal Diode. Amazing loud-speaker reception from 7½ volt battery supply
- REPANCO "TRANSEVEN"** Envelope 1/6 (post 3d.)
A new 7 Transistor superhet Portable with preset station tuning using Repanco transistor components

MAIL ORDER and TRADE—

RADIO EXPERIMENTAL PRODUCTS
LIMITED
33 MUCH PARK STREET COVENTRY
Telephone 62572

WHOLESALE and EXPORT—

REPANCO LTD
O'BRIENS BUILDINGS
203-269 FOLESHILL ROAD COVENTRY
Telephone 40594

If you require a stockist of High Grade Components, we are the people for the job.

912 Plus Amplifier chassis, fully punched, 16-gauge aluminium ...	14/6
912 Plus Amplifier front panel, finished gilt with black lettering ...	7/6
Hunts Capacitor Kits	
Conversion from 912 to 912 Plus ...	11/10½
Kit for pre-amplifier unit ...	17/6
Complete kit for 912 Plus ...	55/-
"Lab" Resistor Kit complete with potentiometers ...	32/4
Elstone Transformers	
Output type OT/912 ...	45/-
Mains type MT/912 ...	44/-
Smoothing Choke, type SC/80 ...	22/6
McMurdo Valveholders	
Screened ...	2/-
Unscreened ...	1/-

The High Fidelity Co

18 MELVILLE ROAD EDGBASTON
BIRMINGHAM 16

(Proprietors Kendall & Mousley Ltd)

The **OSMOR** 'SATELLITE' FM RECEIVER

As described and recommended in this issue on pages 406 to 413

A high selectivity, completely stable and drift-free tuner for adding to an existing radio or radiogram, or hi-fidelity amplifier. Installation is extremely simple and convenient because of the small size of the unit and the fact that a tuning scale is not required. The special frequency control circuit permits no drift at all and ensures that the switch-tuned stations are held precisely.

Complete Kit **£7.5.0** less valves

OSMOR RADIO PRODUCTS LTD

(Dept. RC18)

418 Brighton Road South Croydon Surrey

Telephone Croydon 5148/9

For a really
professional finish
use . . .

PANEL-SIGNS TRANSFERS

Set No. 1: Receivers and Amplifiers
Five sheets 8½" × 5½" containing one Large scale, twelve control panels and wording. 3s. 6d. Postage 2d.

Set No. 2: Test Instruments
Five sheets 8½" × 5½" containing two Medium scales, twelve control panels and wording. 3s. 6d. Postage 2d.

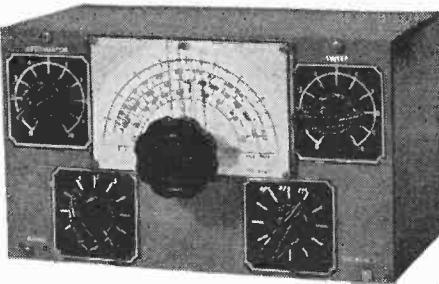

Set No. 3: Wording
Wording for Receivers, Amplifiers, Transmitters, Test Equipment and other Radio Apparatus.
4 Sheets, Approx. 400 words, 2s. 6d. Postage 2d.

Panel-Signs Transfers Fixing Varnish
1s. per bottle Postage 4d.

Note—all wording is in white

Published by

DATA PUBLICATIONS LTD

57 MAIDA VALE · LONDON W9

Telephone CUNningham 6141 (2 lines)

Telegrams Databux London

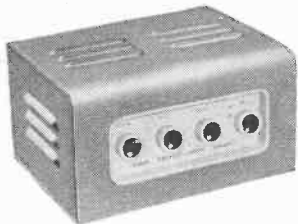

E.A.R. TRIPLE FOUR Ultra Linear Amplifier

Six watt push-pull output with independent Bass, Treble and equalisation controls. Power take-off available for FM tuner. Leaflet on request.

PRICE £11.11.0

GREAT NEWS

for all constructors

The "Universal" chassis assembly. Over 50 different chassis sizes from 4" to 14", or larger, quickly and easily made up. Can be used over and over again. Send S.A.E. for list.

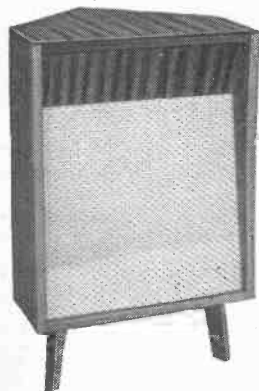

HOME RADIO OF MITCHAM

We carry the full range of the
W.B. STENTORIAN CABINETS
for Speakers and Equipment

Eleven different models beautifully made and finished, and easily assembled using only a screwdriver. Packed flat in cartons complete with screws ready for despatch by return. Send 3d. stamp for illustrated leaflet.

ALL PARTS IN STOCK

for these kits

Jason FM Tuner, Jason "Mercury," Mullard "3-3," Mullard Five-Ten, G.E.C. Junior Amplifier, G.E.C. "912," R.C. 1-Valve Short Waver, Hiwayman, Three Dee, Full Tone Amplifier.
Send s.a.c. for price lists

HOME RADIO (MITCHAM) LTD

187 London Road, Mitcham, Surrey. MIT 3282

ARTHURS HAVE IT !

Large Stocks of Valves and C.R.T.s
Full Range of Meters available
Avo, Taylor, Cossor, Advance, etc.
Particulars on Request

FM Kit of Parts £5, less valves
(Ref. Radio Constructor July 1954)

Amplifier Tape Recorders and
Loudspeakers

Jason FM Tuner Unit £15 17 0
Jason Power Pack £3 10 0
Radios and Television always in stock

VALVE MANUALS

Mullard, 10/6; Brimar No. 6, Osram, Part 1
5/-; Osram, Part II, 10/-
Postage 9d. each extra

Publications "Lodestar" Tape Recorder 3/6

Goods offered subject to price alteration and
being unsold

Arthurs first
Est. 1919

Proprietors ARTHUR GRAY LTD

OUR ONLY ADDRESS **Gray House**
150-152 Charing Cross Road
London WC2

TEmple Bar 5833/34 and 4765

High Sensitivity

Miniature moving coil

LOUD SPEAKER

As used in the Perdio Pocket
Transistor Radio

Diameter 2 $\frac{3}{8}$ " Depth $\frac{13}{16}$ "
Impedance 3 ohms

Price including tax, post and packing
27/6. Cash with order. For
this and other miniature components.

Apply

SPECIALISED ELECTRICAL COMPONENTS

9-11 Monmouth Street · London
WC2

The

Radio Constructor

incorporating THE RADIO AMATEUR



CONTENTS FOR JANUARY

VOL. 11 NO. 6

JANUARY 1958

ANNUAL SUBSCRIPTION 25/-
including postage

*Editorial and
Advertising Offices*

57 MAIDA VALE LONDON W9

Telephone

CUNingham 6141
(2 lines)

Telegrams

DATABUX, LONDON

Editor

C. W. C. OVERLAND, G2ATV

Advertising Manager

F. A. BALDWIN, AMIPRE

- 382 Suggested Circuits: A Simple Square Wave Generator, *by G. A. French*
- 386 In Your Workshop
- 391 Understanding Television, Part 1. Basic Theory and Practice, *described by W. G. Morley*
- 397 The "Cooper-Smith" type BPI High-Fidelity Amplifier, Part 2, *by J. Cooper*
- 401 Mains Unit for FM Tuners and other Small Equipment, *described by E. Govier*
- 404 Radio Miscellany, *by Centre Tap*
- 406 The "Satellite" Pre-Tuned FM Unit, *described by D. Peters*
- 414 Technical Forum
- 417 A Switch-Tuned Superhet, *by P. R. Travers*
- 420 A Transistor D.C. Converter—70V at 5mA from a 6V supply, *by D. S. Watson, D.F.H., Grad.I.E.E.*
- 424 Can Anyone Help?
- 425 Magnetic Tape Recording: Microphones—The Weakest Link? Part 1, *by A. Bartlett Still*
- 428 A Sensitive Crystal Receiver, *by R. Wallace*
- 430 Magnetic Ferrites You May Meet, *by R. Gausden*
- 432 Three-Channel Mixer-Amplifier, *by H. Garlick*
- 433 Using the BC 1206A Receiver as a D/F Set, *by "Seafarer"*
- 434 Practical Q and Dynamic Resistance *by J. A. Cusdin*
- 435 Tabulated List of Electrolytic Condensers suitable for Transistorised Equipment, *compiled by E. G. Bulley*

THE CONTENTS of this magazine are strictly copyright and may not be reproduced without obtaining prior permission from the Editor.

ARTICLES appearing in this magazine which describe kits are inserted only on condition that such kits, or special components thereof, are freely available at a trade discount to all retail advertisers.

OPINIONS expressed by contributors are not necessarily those of the Editor or proprietors.

NOTICES

THE EDITOR invites original contributions on construction of radio subjects. All material used will be paid for. Articles should preferably be typewritten, and photographs should be clear and sharp. Diagrams need not be large or perfectly drawn, as our draughtsmen will redraw in most cases, but all relevant information should be included.

All MSS must be accompanied by a stamped addressed envelope for reply or return. Each item must bear the sender's name and address.

TRADE NEWS. Manufacturers, publishers, etc., are invited to submit samples or information of new products for review in this section.

QUERIES. We regret that we are unable to answer queries, other than those arising from articles appearing in this magazine; nor can we advise on modifications to the equipment described in these articles.

ALL CORRESPONDENCE should be addressed to THE RADIO CONSTRUCTOR 57 Maida Vale London W9

REMITTANCES should be made payable to "DATA PUBLICATIONS LTD."

Suggested Circuits

The circuits presented in this series have been designed by G. A. FRENCH, specially for the enthusiast who needs only the circuit and essential relevant data

No. 86. A SIMPLE SQUARE WAVE GENERATOR

ONE OF THE MOST USEFUL DEVICES FOR evaluating the performance of an a.f. amplifier is the square wave generator. Such an instrument can be used to apply a succession of square waves to the input terminals of the amplifier, the output waveform being examined with the aid of an oscilloscope. It is then possible, from the response displayed by the oscilloscope, to identify such shortcomings in the amplifier as poor l.f. or h.f. response, ringing or overshoot on transients, and so on. In this month's Suggested Circuit a simple square wave generator is described, and it is anticipated that this should provide a signal which is very adequate for normal amateur requirements.

The Circuit

The circuit of the square wave generator is shown in Fig. 1. In this diagram the double triode V_1 functions as a multivibrator having a variable frequency control, whilst V_2 operates as a cathode follower and clipper.

A 12AU7 is specified for the V_1 position, and the component values given in the circuit have been calculated around this valve. The anode loads, R_1 and R_2 , have relatively low values, these being chosen to maintain sharp pulse fronts when their associated triodes are entering the "off" condition. It will be noted that the multivibrator is symmetrical, insofar as the values

of $R_1, R_2; R_3, R_4$; and C_1 to C_3, C_4 to C_6 are concerned, this being desirable when square wave generation is intended. Three frequency ranges are given by the coarse control S_1-S_2 , whilst R_5 provides a continuously variable fine frequency control.

On Range 1 the values of C_1-R_4 and C_4-R_3 control the period of time in which the multivibrator exists in one of its two states (i.e. $V_{1(a)}$ "on" or $V_{1(b)}$ "on") and, when the slider of R_5 is at the bottom end of its track, the time may be calculated from the following*:

$$t = C_1 \times R_4 \times \log_e \frac{E - V_{01(a)}}{V_{C1(b)}}$$

where t is time in seconds, E is the applied h.t. voltage, $V_{01(a)}$ is the anode-cathode potential of $V_{1(a)}$ with the coupling condensers disconnected (that is, at zero bias with grid leak returned to cathode) and $V_{C1(b)}$ is the cut-off potential of $V_{1(b)}$ with full h.t. voltage between anode and cathode.

A useful bottom limit repetition frequency for the ranges covered by the square wave generator would be 50 c/s, and we can employ this frequency in the equation just given. The expression t defines the length of time in which the multivibrator exists in one of its two states, with the result that, since the

* O. S. Puckle, "Time Bases (Scanning Generators)," p. 32, second edition. Chapman and Hall Ltd.

multivibrator is a square wave generator, the total period taken up by one cycle will be 2t seconds. We may then start to find the values needed in C_1 and R_4 by stating that we require

$$2t \text{ to equal } \frac{1}{50}$$

$$\therefore t = \frac{1}{100} \text{ secs.}$$

$$= C_1 \times R_4 \times 1.6 \text{ (actually 1.6094)}$$

$$\therefore C_1 \times R_4 = \frac{1}{100} \times \frac{1}{1.6}$$

$$= 0.00625$$

Since it is more difficult to obtain condensers having "awkward" values than resistors having "awkward" values, we may next make

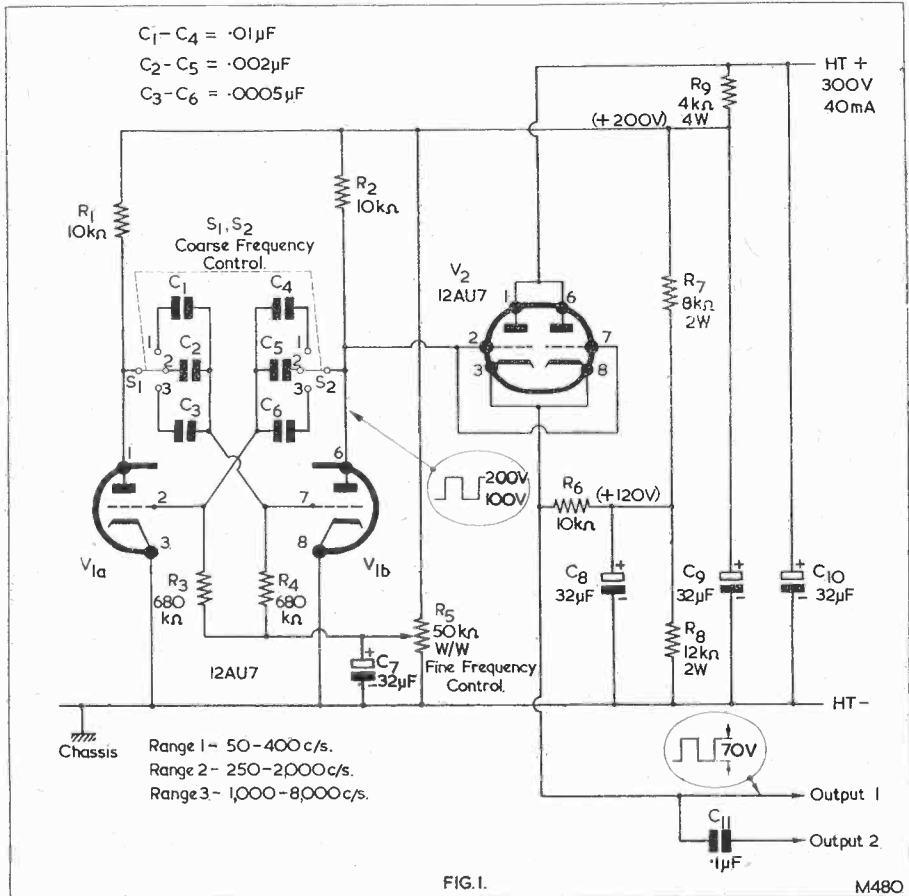

We may next say:

$$\frac{1}{100} = C_1 \times R_4 \times \log_e \frac{E - V_{01(a)}}{V_{c1(b)}}$$

$$= C_1 \times R_4 \times \log_e \frac{200 - 100}{20} \dagger$$

† The figures given here for $V_{01(a)}$ and $V_{c1(b)}$ are approximate and are taken from p. 130 of Brimar Radio Valve and Teletube Manual No. 7.

the arbitrary choice of $0.01\mu\text{F}$ for C_1 , whereupon

$$R_4 = \frac{0.00625}{0.01} \text{ M}\Omega$$

$$= 0.625 \text{ M}\Omega.$$

Such a value is of the order required by this type of circuit. In practice we would take the next preferred value up, of $0.680 \text{ M}\Omega$, or $680 \text{ k}\Omega$, as is done in Fig. 1. The use of a resistor having a value slightly higher than

that calculated will cause the bottom limit frequency in the range covered to be slightly lower than 50 c/s, not an undesirable point. There is, of course, no necessity to calculate the values of R_3 and C_4 , as these will be equivalent to those of R_4 and C_1 .

The values of anode-to-grid coupling condensers needed for the remaining two ranges selected by S_1 - S_2 may be easily found, due to the fact that the capacity required will vary inversely as repetition frequency. Thus, in Fig. 1, C_2 and C_5 are specified as $0.002\mu\text{F}$ (this corresponding to a frequency of 250 c/s), and C_3 and C_6 are specified as $0.0005\mu\text{F}$ (this corresponding to a frequency of 1,000 c/s).

All the component values and frequencies just discussed are calculated for the condition where the slider of R_5 is at the bottom end of its track. If R_5 slider is moved up the track, the repetition frequency of the square wave generator increases, and it should be possible to obtain a frequency ratio approaching 10 : 1 over the range of R_5 . (A ratio of 8 : 1 is assumed in the figures given in Fig. 1.) As may be seen, this gives quite a large amount of overlap on the ranges selected by S_1 - S_2 . If desired, the values specified for C_1 to C_6 may be modified to provide a greater overall coverage with less overlap between ranges. However, it may not prove desirable to go very far below 50 c/s with the present circuit, as this may necessitate increases in the values of the electrolytic condensers. Also the existing top frequency (approaching 10 kc/s) may already be a little ambitious for a simple generator of the type discussed here, and it might be found difficult to exceed it to any great extent whilst retaining good pulse shape.

Shaping

The waveform appearing at the anode of a valve in a multivibrator of the type used here is not entirely square, and suffers from two shortcomings. The first of these is due to the fact that when the anode goes negative it usually overshoots, causing a negative-going pip to appear at the end of the downward pulse. The reason for this pip is that grid current flows initially for a short period before the grid settles down to zero potential. The second shortcoming is that, when the anode goes positive, the front edge of the positive-going pulse tends to become rounded. This effect is caused by the time constant of the anode load with the capacity between anode and chassis. In the square wave generator discussed in this article, the low values chosen for R_1 and R_2 tend to make the pip at the end of the negative swing more pronounced whilst, at the same time, making the positive swing less rounded. It is anticipated that any rounding of the positive swing will be negligible at the frequencies covered; although if any trouble is experienced on this score at high repetition fre-

quencies a simple clipper is shown in Fig. 2. The negative pip on the anode waveform is removed by V_2 .

V_2 functions as a cathode follower whose cathode is returned to a potential higher than that at the anode of $V_{1(b)}$ when this valve is "on." The voltage anticipated at $V_{1(b)}$ anode is of the order of 100 volts. The cathode of V_2 is returned to a positive potential of 120 volts, with the result that V_2 cuts off when $V_{1(b)}$ anode is approaching the lower part of its negative swing. The negative pip is, therefore, not amplified by V_2 and does not appear in the output of the generator. When $V_{1(b)}$ anode goes positive, V_2 cuts in again and functions as a normal cathode follower. The only disadvantage with this technique is that, on positive pulses, the output impedance of the generator is equal to R_6 shunted by the output impedance of V_2 , whilst on negative pulses it is equal to R_6 alone. However, this should cause no trouble if the generator output is connected to a relatively high impedance (say $100k\Omega$ or greater) in the tests required of it. The valve type chosen for the V_2 position is not of great importance provided that it can handle the signal passed to it. A second 12AU7 with both triodes strapped is shown in Fig. 1 to provide an example of what is required, but a single 12AU7 triode would not be overloaded in this application.

The output of the square wave generator will be of the order of 70 volts peak to peak. If this is attenuated by normal potentiometer methods, capacity may be needed across the top half of the potential divider to maintain pulse sharpness.

Fig. 2 illustrates a clipper which may be added to clear rounded positive-going leading edges if these should become evident at high repetition frequencies. Its functioning is extremely simple, all that it does being to prevent the output positive pulse rising above its delay voltage. The top, rounded, part of the pulse then becomes lost.

Practical Points

One or two practical points need to be discussed with regard to the circuit.

The first of these is that the square wave repetition frequency is liable to vary with h.t. voltage and with multivibrator valves having different grid bases. The variations should not be excessive, but the possibility of their occurrence should not be ignored.

An attempt should be made to keep the wiring to the two triodes $V_{1(a)}$ and $V_{1(b)}$ reasonably symmetrical around the valveholder. Careful and symmetrical layout is required also around S_1 - S_2 , which should be mounted close to the valveholder. The stray capacity between the two sets of anode-to-grid condensers must be kept low.

In order to obtain a mark-space ratio of 50 : 50 the condensers C_1 to C_3 should match their counterparts C_4 to C_6 , and R_3 should match R_4 . It will probably be found easiest to do this matching *in situ*, the output response being checked on an oscilloscope.

It will be noted that somewhat large values are specified for the various electrolytic condensers employed in the circuit. The writer has, perhaps, been a little over-cautious here, and it may be possible to employ lower values in some of the positions. This point may be checked experimentally if desired, the output waveform being examined whilst the generator is set to its lowest frequency.

Appendix

The formula

$$t = C_1 \times R_4 \times \log_e \frac{E - V_{01(a)}}{V_{C1(b)}}$$

may be a little unfamiliar and is derived from

$$t = C_1 \times R_4 \times \log_e \frac{A}{B}$$

when t represents the time in seconds taken for a potential in a CR to fall (or rise) from A to B volts. In the case of the multi-vibrator some slight confusion is sometimes occasioned by the fact that the voltage $V_{01(a)}$ is of a "positive" nature and the voltage $V_{C1(b)}$ is of a "negative" nature. An easy way of visualising the use of the equation consists of considering the potential on the right-hand plate of C_1 when $V_{1(b)}$ is "on." This potential will be zero with respect to chassis. At the same time the potential on the left-hand plate of C_1 will be that of the h.t. line, i.e. E . At the instant when the multi-

vibrator changes over, the left-hand plate of C_1 drops from E volts to $V_{01(a)}$ volts, "carrying" its right-hand plate with it. The potential of the right-hand plate will then be $E - V_{01(a)}$ negative to chassis. C_1 next commences to discharge into R_4 until it reaches the cut-off voltage of $V_{1(b)}$, i.e. $V_{C1(b)}$, this being also *negative* with respect to chassis.

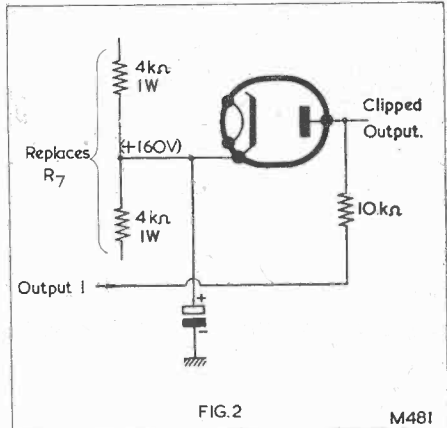

The equation

$$t = CR \log_e \frac{A}{B}$$

employs Napierian logs as a mathematical short-cut. It is also possible to find the time taken for a CR to change from potential A to potential B in terms of its time constant by simply examining the exponential curves published in some textbooks.

BOOKS AND CATALOGUES RECEIVED

We have received from Repanco Ltd. of 203-269 Foleshill Road, Coventry, a copy of their latest brochure, this being available direct from them on receipt of an s.a.e. This interesting literature contains details and profuse illustrations of the many well-known Repanco products. Apart from coils, the brochure includes details of a dual-range Ferrite rod aerial, high gain 3-waveband superhet pack, a range of i.f. transformers, midget output and interstage transformers and f.m. coil sets. In addition to components, a feature is made of their well-known kit assemblies, these including the "Three Dee" transistor receiver, a High Gain Band III Converter, The "Hiwayman" portable receiver, the "Transeven" transistor portable and FM Tuner Unit.

R.S.G.B. AMATEUR RADIO CALL BOOK 1957-1958 EDITION. This latest edition of the call book is the most up-to-date list of United Kingdom call-signs yet published, the list being based on information supplied to the R.S.G.B. by the Radio Services Dept. of the G.P.O. Of 72 pages, with stiff card cover,

and containing hundreds of correct call signs together with QTH's, the book also includes an Alphabetical List of Countries and Allocated Frequencies, a List of Countries in Prefix Order, together with an interesting chapter on the R.S.G.B.—Its Aims and Objects. The Call Book represents extremely good value at 3/6 per copy plus 3d. postage, and it may be obtained direct from R.S.G.B. Sales Dept., New Ruskin House, Little Russell Street, London, W.C.1.

G.E.C. VALVE MANUAL Part I (Second Edition). The latest edition of this manual has been completely revised, and it is now available direct from the G.E.C. Valve and Electronics Dept., Magnet House, Kingsway, London, W.C.2., price 7/6. Composed of 227 pages packed with all the relevant information on the G.E.C. range of receiving valves, cathode ray tubes, semiconductor devices and complete with comparative tables, data tables of maintenance and valve types, etc.

continued on page 425

In your Workshop

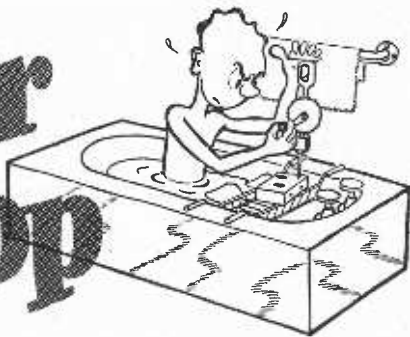

Smithy the Serviceman, aided by his able assistant Dick, continues to run the Workshop

WHATEVER ELSE MIGHT BE SAID ABOUT Dick, it could not be denied that he was a person who always tried to profit by past experience. When, therefore, he made his way to the workshop on New Year's Day, not only was he some five minutes earlier than his usual arrival time, but he was also armed with a sovereign remedy which, on the previous First of January, had been effervescently efficacious in dispelling Smithy's New Year's Eve blues. However, history has a habit of not always repeating itself, and Dick experienced what was almost a pang of disappointment when he found that Smithy's car was already parked outside the workshop and, when he entered, that the Serviceman was already sitting at his bench glancing through some service information sheets which had recently arrived.

"Happy New Year, Dick," called out Smithy, as Dick closed the door behind him.

Dick examined the Serviceman carefully for signs of wear and tear.

"The same to you, Smithy," he replied eventually. He took a glass tube of tablets from his overcoat pocket with some ostentation and placed it on the bench.

Smithy noted the movement and grinned.

"Not this year, Dick," he smiled. "I appreciate your desire to minister to the sick, but I was able to talk myself out of the annual shindig at the club last night. As you know, their usual excuse to get me round there on New Year's Eve is to tell me that their dance amplifier has gone wrong. However, I forestalled them this year by making certain it was O.K. beforehand."

"Well, that was a good idea," remarked Dick, a little regretfully, "and I suppose that

you're now all ready to begin a full day's work."

"That's perfectly correct," agreed Smithy briskly. "Let's start the New Year right!"

Resistor Failures

Smithy proved himself true to his word, and before long was deeply engrossed in the repair of a record-changer, whilst Dick took over the servicing of a television receiver the Serviceman had earmarked for his attention. Whatever the degree of activity in the workshop, Dick was not a person to remain quiet for very long, and his voice soon broke the silence.

"I've got rather a queer snag here, Smithy," he called out, "and I don't quite know whether I've cleared it or not."

"Fair enough," grunted Smithy, without turning round. "Tell us the story."

"Well, the set I've got on the bench came in with two faults on the job ticket," said Dick, "these being: 'intermittent flashes on screen followed by frame collapse.' When I switched the set on I got a thin horizontal line on the screen, so the first obvious thing I had to do was to get the frame deflection circuit working properly."

"I hope," interrupted Smithy, "that you did what I told you some time ago after finding out that the set was reported to have frame scan trouble."

"You mean turning the brilliance right back when switching the set on, and then bringing it up cautiously after the e.h.t. came on? Oh yes, I did that!"

"Good show," commended Smithy. "The idea behind that procedure is, of course, to avoid burning the screen by the concentrated

beam current on the central horizontal line which results from lack of frame scan. Modern tubes seem to be far more able to stand up to concentrated beam currents of this type than the older types, but it would be silly not to take a simple precaution of this type."

"Which precaution I did, of course, take," Dick reminded Smithy. "Anyway, to get back to the story, I followed the usual procedure; first of all replacing the frame multivibrator and frame output valves. This provided no cure and something a little more complicated was obviously wrong. A few minutes prodding with my trusty multimeter showed that the anode feed resistor to one half of the frame multivibrator had gone open-circuit. There was no visual sign of the resistor burning up or anything like that, incidentally; in fact, it looked factory fresh."

"That's a fairly common state of affairs," commented Smithy, breaking in again. "Resistors which have pulse voltages across them, as this one did, are fairly liable to go o/c without any change in their outside appearance, even when the overall power they handle, including the pulse, is well within their wattage rating. Very often, unfortunately, they go high in value before they finally pack up, and they can give you some rather obscure faults if you aren't keeping an eye open for them."

"I can see," said Dick, a little despairingly, "that this is going to be one of those tales where the text is crowded out by the footnotes! Anyway, returning to my own snag, I swapped the faulty resistor, and the frame scan returned to normal. Incidentally, the faulty resistor was a quarter-watt component, but I used a half-watt replacement because that was all I could find in the spares box."

"You probably did the right thing there," interrupted Smithy once more. "Whenever I replace a resistor handling pulse voltages I usually try to use a wattage rating higher than that of the faulty component. My line of reasoning is that, although the incidence of failures in the smaller wattage resistors chosen by the set manufacturer may be small, it should be even smaller with a high wattage resistor. Also I always do my best to use *new* resistors of reliable manufacture in pulse positions, taking especial care to avoid war-surplus components and the like. I feel pretty certain that my ideas on this subject are correct, because I've never had any of my 'super-cautious' resistors fail me yet."

"Well, while resistors appear to be the subject of the day," said Dick resignedly, "what about using wire-wound components?"

"You've raised rather a thorny question there," commented Smithy, "because I've had quite a little trouble in the past with wire-

wound resistors in pulse applications; although these were not necessarily in time-base stages. The worst cases have been in such positions as video output anode loads, and I have got into the habit of replacing these loads when they have gone o/c (their normal fault) with carbon resistors of equal wattage. Sometimes it is necessary to use two carbon resistors, in series or in parallel, to make up the wattage rating required, and they are nearly always more bulky than their wire-wound equivalents. Nevertheless, if there is room on the chassis for them they seem to give far less trouble, and I haven't had any let me down afterwards. By the way, you haven't yet told me what snag it was in your set which was worrying you?"

Corona

"Snag?" said Dick. "What snag? Oh yes, I seem to remember *something* which was troubling me."

Smithy looked suspiciously at Dick's guileless face.

"The trouble with me," continued Dick, just a shade too elaborately, "is that I am so interested in radio matters that I am very easily sidetracked from my subject by people with more knowledge and greater tenacity of purpose than myself. Anyway, I've picked up quite a bit about resistors in the last . . ."

"Come off it!" interjected Smithy. "Just you apply your mighty brain to the set you're fixing! You had just replaced the faulty resistor in the frame oscillator circuit."

"That's right," replied Dick returning, and warming up, to his tale. "As I said, I got the frame scan working normally again. What has been worrying me since then is the second snag marked on the job ticket: intermittent flashing on the screen. I can't get any flashes to show up on the screen at all now that I've fixed the frame circuits. Also I can't see why a faulty frame circuit could cause such flashes."

Dick showed Smithy the set under discussion. This was displaying a perfectly normal B.B.C. test card.

"Well, that seems to be O.K.," said Smithy, examining the picture. "I very much doubt if the frame circuit ever caused the flashes, assuming that they existed at all or weren't the result of external interference. Now and again, customer reports mention flashes on the screen before the packing-up of their sets, despite the fact that for the past few years they've put up with exactly the same flashes every day when their next door neighbours run the vacuum cleaner. Anyway, we should still make absolutely certain that there's nothing really wrong with the set."

With these words Smithy removed the aerial plug from the receiver input socket and

fitted a short length of flexible wire, which happened to be lying around, to its centre conductor. Using this wire as an aerial, Smithy turned up the contrast and sensitivity controls of the receiver and obtained a very weak and noisy test card, which was just capable of being locked. As he and Dick watched the picture it suddenly broke up into a number of large white flashes. These disappeared and reappeared at random intervals and did not appear to be affected by experimental taps on the chassis.

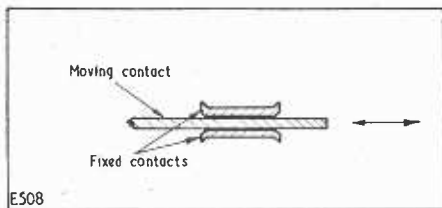

Fig. 1. The normal appearance of the fixed and moving contacts in a rotary switch

"Well, it seems certain that your set *has* got a fault," commented Smithy, "and it is very probably corona or sparking in the line output stage or e.h.t. wiring. The trouble didn't show up when you had the outside aerial connected up because this is some distance away from the radiating source—that is, the set itself—and because the reasonably strong B.B.C. signal we get from that aerial is liable to swamp out any radiation it *does* pick up. The short length of wire I used as an aerial was, on the other hand, right on top of the radiating source and that, together with the weak signal we then picked up, caused the flashes to appear. I should imagine that the customer's aerial is fairly close to the receiver, and that it picks up the radiation at corresponding strength. By the way, I should mention that when you are carrying out a workshop test like the one I have just done, you want to ensure that you aren't picking up corona radiation from any other t.v. set that might happen to be switched on!"

"O.K.," said Dick. "It looks as though I shall have to start off on a hunt for corona."

"It shouldn't be too hard," commented Smithy. "Corona is usually pretty easy to find."

Smithy returned to his neglected changer, and Dick, turning out the light above his bench, inspected the television chassis for corona under the darkened conditions resulting thereby. Peace settled on the workshop once more, and some fifteen minutes elapsed before a cry of desperation rose from Dick.

"Smithy," he called out, "I have just discovered something impossible!"

With more than the suspicion of a sigh Smithy left his work and wandered over to Dick's bench.

"What have you found?"

"Well," said Dick, a puzzled frown on his face, "I started looking for corona just as you asked me to do, but I could find no evidence of it anywhere. I also listened carefully—you can sometimes hear line output transformer corona singing away to itself in hidden corners—but still had no luck. There wasn't even that delicate scent which corona usually causes. I next decided to make a few simple checks on the line output transformer with the testmeter whereupon, lo and behold, I find that the e.h.t. overwind is completely open-circuit! When I first got an o/c indication on the meter I thought that I might have had it switched to too low a range, and that the overwind was one of those wound with Eureka wire to overcome ringing. But when I checked on a higher range I still got no continuity. So we now come to the 64,000 question: how can a set with an open-circuit overwind deliver e.h.t. and display a picture?"

Smithy grinned.

"That's an oldie," he chuckled. "In fact I should have warned you about such a possibility before you started. It occasionally happens that an e.h.t. overwind goes o/c in such a manner that, at the point where the break occurs, the two conductors are close enough together for a spark to jump across the gap during the hefty voltage pulse occurring at the flyback. This spark can complete the circuit adequately enough to enable the e.h.t. reservoir condenser to be kept charged up. We seem to have been lucky enough here to have stumbled on a line output transformer when it is just beginning to exhibit this fault and I daresay that, if we ran it for a number of hours, the e.h.t. regulation would get worse and worse until the transformer finally packed up altogether. As you have also almost certainly located the cause of the flashing on the screen as well as a faulty line output transformer, I think you have done a very good bit of work."

"Oh, fine," Dick said, pleased at the compliment. "I presume that a new l.o.p.t. is called for."

"It is, indeed," replied Smithy, "and I think we have a replacement for the particular type required in stock."

Dick found a replacement transformer and spent the next twenty minutes fitting it into the receiver, whilst Smithy returned to his bench. The new transformer functioned correctly when Dick switched on his receiver, and the flashing on the screen did not return. Satisfied, Dick replaced the chassis in its cabinet, gave it a final test, and carried it over to the rack for finished work.

Switch Cleaning

Dick was a little disgruntled to find that the next job on his list was not a television set at all but, instead, a rather aged four-plus-one medium and long wave receiver housed in a battered plastic cabinet. He noted that the set was stated to have a noisy wave-change switch, and a quick check before removing the chassis from its cabinet confirmed this fact. Dick next examined the switch itself and decided that he had, for the umpteenth time that morning, encountered something a little outside his previous experience.

"Hey, Smithy," he called out. "Have you ever seen a wafer switch whose contacts are as worn as this? Why, the plating is completely removed from the moving contact!"

The long-suffering Serviceman once more left his work and walked over to Dick's bench.

"Well, it certainly seems to have seen some use," he commented.

"I suppose the contacts were poorly plated in the first place," remarked Dick.

"I don't think so," replied Smithy, bending over and examining the switch more carefully. "If you look closely you'll see that these contacts are as dry as a bone. I would say that someone in the past has cleaned it too generously with carbon tet, or whatever other cleaning solvent he used."

"But surely you're *supposed* to use a cleaning solvent on a noisy wafer switch!"

"Not entirely," returned Smithy, pulling up a pad of paper. "Look, I'll show you what happens between two contacts in a simple wafer switch. When you examine a pair of such contacts visually, you have the impression of smooth surfaces pressing against each other. Like this (Fig. 1). However, if you were to magnify the surfaces sufficiently you would find that they are by no means as 'smooth' as they appear at first sight; and you would have an irregular 'hill and valley' effect like this (Fig. 2). The points of contact occur at the places where 'hills' touch each other, and there are sufficient of these—when the overall contact area is considered—for the switch to pass the current it is required to pass. At the same time, and due to the surface irregularities in either contact, a certain amount of very undesirable friction and abrasion is liable to occur whenever one contact is moved relative to the other.

"The easiest way of reducing the friction and abrasion consists of applying a lubricant to the contact surfaces, an obvious choice here being a lubricating grease which has no chemical action on the metal of the contacts or on any insulation which is near to them. This grease would also, incidentally, confer the secondary advantage of covering the contacts and reducing long-term oxidation from the air. When a wafer switch leaves the

factory, grease will already have been applied to its contacts by the manufacturer."

"Ah," said Dick, "now that raises a point which has always puzzled me. I have never quite been able to understand how you get connections between a pair of contacts when both are greased. Surely there must be a very thin film of grease between the two which keeps them apart."

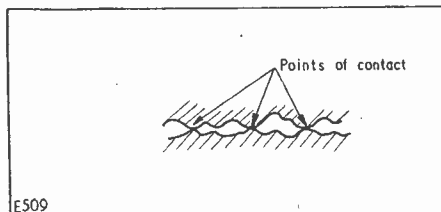

Fig. 2. If a cross-section through two contacts were sufficiently magnified, the surface irregularities would appear like this

"What happens in practice," said Smithy, answering this point, "is that the grease is forced out from the points where the 'hills' in either contact meet, with the result that you still have the same number of contact points as were given before the grease was applied. The grease is forced into the 'valleys,' whereupon it is ready to provide lubrication when one of the contacts is moved relative to the other.

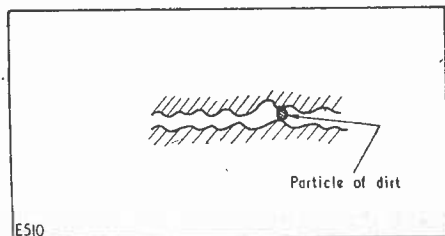

Fig. 3. A sufficiently large particle of dirt between the two contact surfaces shown in Fig. 2 prevents the "hills" in either surface touching each other

"So far, so good! Unfortunately nothing is perfect, especially in electronics, and it is possible with the passage of time for particles of dirt to fall on the switch, become embedded in the grease, and finally find their way between the two contacts. If any particle of dirt is large enough it forces the two contacts apart so that even the 'hills' on their surfaces do not touch each other (Fig. 3). The result of this is that the switch becomes intermittent in operation and we class it as being 'noisy.'"

"Whereupon a possible cure," chimed in Dick, "consists of swilling it out with a solvent such as carbon tetrachloride or trichlorethylene."

"Exactly," Smithy said. "The solvent flushes away the grease, removing the dirt particles existing in it, and the switch reverts to normal operation once more. The only snag is that if you are too liberal with the solvent—a human enough tendency—you are liable to wash all the grease away and the contacts have to work henceforward without lubrication. The result you see in the switch before you. It is quite possible that the owner of this particular set spends quite a bit of his time changing over from the Home Service on medium waves to the Light programme on long waves. If he operates the switch only three times in an evening, that still corresponds to a thousand operations a year. After several years, with the thousands of operations involved, it would not be at all untoward for the switch contact plating to be worn away, as has happened here."

"I see," said Dick, reflectively. "The moral of this, I suppose, is to always grease the contacts of a wafer switch after cleaning."

"That's right," replied Smithy, "and don't forget that *both* sides of the rotor plate should be greased. Incidentally, you don't need to use much grease. If it is applied at a few strategic points, the movement of the switch itself is sufficient to ensure that it gets into the right places. If you're pushed, Vaseline is a fairly reasonable grease for switch lubrication; but I would strongly advise you to use a proper 'contact grease' which is made by a reputable firm for that express purpose. An alternative idea consists of using a contact

cleaning fluid which is made up of a solvent in which a grease is dissolved. When the solvent evaporates a new film of grease is then left on the contacts.

"I think I should add that we have only been discussing wave-change switches up to now. These types of switch can be very difficult to replace when they use a complicated contact layout, but they are chicken-feed compared with the contact sets on things like t.v. turret tuners. The contacts in t.v. tuners need just as much attention as do those in small rotary switches, and they have to stand up to a terrific amount of usage in the average customer's home."

"You know," remarked Dick. "I was a little cheesed off at having to tackle this little radio, but it's helped to teach me something about t.v. after all!"

Late Night Final

Smithy was just about to return to his bench when Dick raised yet another question.

"By the way," he remarked casually. "I've just recalled something that's been puzzling me, off and on, all the morning. Do you remember saying, when you first came in, that you fixed your club's dance amplifier earlier on so that you wouldn't be talked into having a late session on New Year's Eve? What puzzles me is that I know you've been very busy over the last few weeks and I can't quite see when you *did* manage to check it over."

Smithy grinned a little sheepishly.

"I'm afraid," he replied, "that I was talked into looking it over on Christmas Eve. And if you'd had the head I had on Christmas Day . . .!"

Adding a Feeder Unit and/or Gram Motor to the "Cooper-Smith" Type BPI High Fidelity Amplifier

The chassis is punched to take two extra Cinch sockets. One of these may be used to provide a mains connection for the gram motor, and the other a 4-pin connection for supplying power to a tuning unit, etc. Up to 30mA may be drawn from the h.t. source for this purpose, but in such a case the 5Z4 rectifier should be replaced by a 5V4.

1.5A may also be drawn for the heater supply of the unit, but if more than this is needed an Electrovoice type 195A power transformer, which has an additional heater winding, should be substituted for that originally specified.

Most modern tuning units require a voltage of around 250V at 30mA, in which case a 2k Ω 5W resistor should be inserted in circuits, this being decoupled with an 8 μ F 350V condenser. Other voltages and currents will require a different resistor value, which may be arrived at by Ohm's Law.

The take-off point for h.t. is a junction of C₁₀ and L₁.

New Rectangular Loudspeaker by Plessey

In instances where television, radio and gramophone cabinet space is severely restricted, it has been considered good practice to employ an electrical loudspeaker. This arrangement has been generally satisfactory; however, the fullest use has not been made of the loudspeaker panel area.

To meet this requirement the Plessey Co. Ltd. has now introduced a new 9in x 4in rectangular-shape loudspeaker which provides considerably improved high efficiency and firm low frequency performance. Moreover, it has extremely good power-handling ability.

It can be supplied with alternative cones made from different qualities of materials to give a varied high note response to suit customer's specific requirements. The standard cone has a smooth expanded high note characteristic. This speaker is ideal for use in table gramophones, car radios, table television sets and a.m./f.m. receivers, for which quality of reproduction above average is desired. The 2in voice coil can be supplied with any of the Plessey 2in range of magnets from 7,000 to 12,000 gauss.

UNDERSTANDING TELEVISION

PART I

By W. G. MORLEY

The first in a series of articles which, starting from first principles, describes the basic theory and practice of television

TELEVISION HAS NOW BECOME AS MUCH AN accepted part of the British domestic scene as was radio in the days before the war. The writer has had the fortune, or misfortune, largely to "grow up with" television, insofar that he was of an age to just appreciate the engineering techniques involved when the B.B.C. first launched its high definition service in 1936. Much water has flown under the t.v. bridge since that time, and receivers have developed to a state which, so far as black-and-white television is concerned, is roughly parallel to that occupied before the war by the four-plus-one sound radio. Present-day televisors have, in fact, stabilised into designs which are readily capable of being understood and appreciated by anyone conversant with the fairly simple circuit theories involved; this point being especially true of sets intended for operation in "soak" areas (i.e. areas of strong signal strength). Soak area sets do not require exceptionally high sensitivity levels and can be consequently manufactured to sell at a relatively low price. The effects of competition then necessitate the avoidance of extensive frills and gadgetry, with the consequence that these sets have circuits which are straightforward and easy to follow. Fringe area sets, possessing extra sensitivity, flywheel sync, gated a.g.c. and so on, are liable to incur somewhat more head-scratching on the part of the designer and, later, the service engineer, who has to sort out the snags which may develop in them. Even here,

nevertheless, the practical circuitry for these "extras" is not too far removed from the sort of thing first principles would cause one to expect.

It is against this background of inherently stable television receiver design that the writer would like to introduce this first article in the "Understanding Television" series. The series is intended to provide an insight for the beginner, and also, perhaps, for the more seasoned veteran, into contemporary television receiver design; and the writer hopes that he will be able to lay stress on some of the design, manufacturing and servicing viewpoints which are involved. The articles are not intended to be a batch of technical papers destined for presentation to an engineering association. They are, instead, meant to provide a commonsense and practical approach to the subject for the benefit of commonsense and practical people.

Television Transmission

If we are going to get anywhere in a practical study of television, we must first of all get down to the basic elements of television as a *medium* capable of causing scenes occurring at one point to be reproduced at another, the only interconnection being provided by wires and/or radio links.

As we all know, it is possible to provide a reproduction of any scene by breaking it down into a number of small parts and of building these up again in their correct positions at a remote point. Newspaper photographs are a

well-known example of this technique, the picture being reproduced in this instance by initially breaking it down into a large number of dots. When published, such a picture then indicates light parts of the scene by printing dots having relatively small areas, and dark parts of the scene by printing dots with relatively large areas. Intermediate shades are reproduced by dots of corresponding areas.

Due to the nature of the newsprint on which it is printed, it is unusual for a newspaper picture to be reproduced with more than 40 dots to the inch. A publication employing higher grade paper, such as *The Radio Constructor*, is able to reproduce pictures having 100 dots to the inch. If a photograph appearing in this magazine is held alongside a newspaper photograph, the improvement in detail offered by the finer dot structure becomes very apparent: and it might not be to our disadvantage to spend a few moments enlarging on this particular point right now.

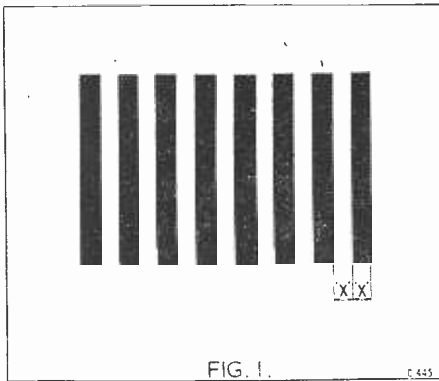

Fig. 1. A striped design which could be used to check the resolution of a picture reproducing system

The ability of a printed picture to *define*, or *resolve*, detail could be quite accurately expressed in terms of its *resolution* or *definition* (the terms are synonymous here). A photograph reproduced in *The Radio Constructor* is capable of showing up details which occupy only one-hundredth of an inch in the printed picture, because such details may be represented by single dots. For instance, if we tried to reproduce the striped design shown in Fig. 1 in *The Radio Constructor*, this could be done even when the dimensions "x" were only one-hundredth of an inch wide. However, if the dimensions "x" were retained at one-hundredth of an

inch, Fig. 1 would be reproduced in a newspaper photograph as having an overall grey colour only, it being impossible for the newspaper photograph to reproduce the pattern correctly when the details are smaller than the dots of which the reproduction is constructed. The newspaper picture *could*, however, reproduce Fig. 1 if the dimensions "x" were increased to one-fortieth of an inch.

In practice, the reproduction of the Fig. 1 design would be slightly marred in both *The Radio Constructor* version ($x=1/100$ inch) and the newspaper version ($x=1/40$ inch) because, unless the lines were parallel to the lines of dots on the printing block, the pattern given by the dots themselves would become superimposed on the design. This little illustration, nevertheless, enables us to visualise one possible method of picture make-up and to think of *resolution* in terms with which we are very familiar in ordinary daily life.

Having gone so far, let us now see whether we cannot take a leaf out of the printer's book and try to reproduce television pictures in the same way as they are published in newspapers. From the point of view of elementary theory, the process would be simple; and it was, indeed, the subject of early experiments by Baird. What we would require is something of the nature illustrated in Fig. 2. Here we have a battery of photo-electric cells, each focused on its own "spot" of the picture to be reproduced, and each coupled to its own amplifier and reproducing lamp. The latter could consist of torch bulbs whose brightness was controlled by the brightness of the section of the scene observed by their corresponding photocells. We would then have the situation where the original scene was broken down into its constituent parts (or "dots") by the photocells, and rebuilt at the receiving end by the torch bulbs.

At first sight, the idea of Fig. 2 seems to be reasonable enough, but it soon shows its impracticability when we consider the number of photocells and reproducing lamps which would be needed to give us a satisfactory picture at the receiving end. If, for instance, we wanted to use the device to transmit a picture which was equivalent in detail, or resolution, to that of, say, a newspaper picture five inches square, we would need to have as many photocells and reproducing lamps as there are dots in such a picture. This works out at a grand total of 40,000 ($5 \times 40 \times 5 \times 40$) photocells! A mild comment would be that this is somewhat expensive on photocells and reproducing lamps, to say nothing of the 40,000 amplifiers needed between the two. However, the most costly and unwieldy item in the system overall would be the 40,000 sets of lines needed between the transmitting and receiving ends.

From the practical point of view, therefore, and particularly when the transmitting and receiving ends are widely separated, the scheme is of no use at all.

and receiver by the use of the rotating switches makes the device of Fig. 3 a somewhat cheaper proposition than that of Fig. 2, the idea is still quite useless for practical

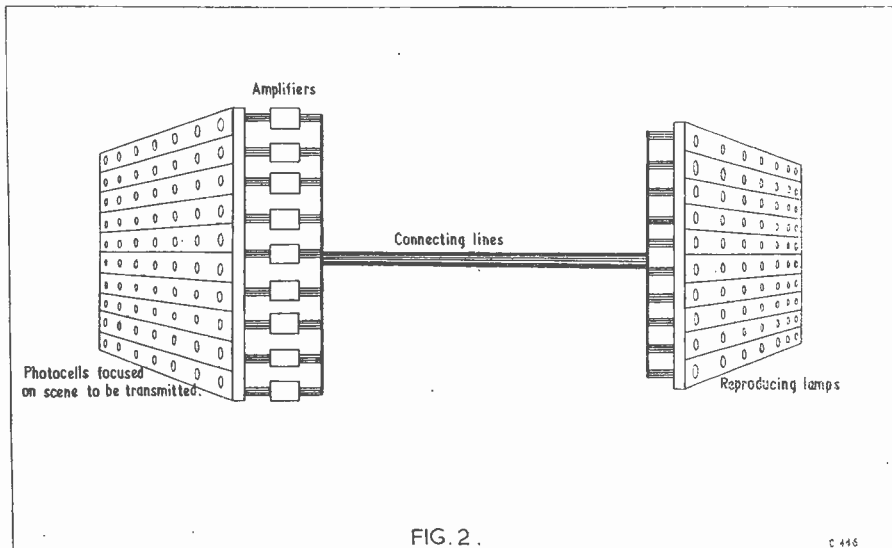

FIG. 2. Television pictures could theoretically be transmitted by a system such as that shown here. Each photocell is focused onto one particular spot of the scene to be transmitted, its corresponding reproducing lamp being illuminated to a brightness level equivalent to that actuating the photocell.

It is possible to improve the idea slightly, this being done by obviating the 40,000 interconnecting lines with the aid of the arrangement shown in Fig. 3. In this diagram the output of each photocell is applied to a fixed contact on a rotating switch, the switch's moving contact connecting to a single line which travels to the receiving end. A similar switch at the receiving end of the line then transfers the signal on the line to the lamp which corresponds to the photocell selected at the transmitting end. Provided that both switches were kept exactly in step (or in synchronism) and were rotated very quickly, it would then be theoretically possible to transmit a picture over the single interconnecting line. To reduce the flicker caused by each reproducing lamp being illuminated for a very short interval, it would be necessary for the lamps to have a *persistence* which was such that their illumination did not drop excessively in the periods between their actuation by the switch. The persistence of vision in the human eye itself would also help to overcome the effect of flicker.

Although our change from 40,000 lines to a single connecting line between transmitter

purposes. However, the principles involved are of interest because Fig. 3 illustrates a basic *sequential* transmitting technique. In Fig. 2 all our photocells were connected to their associated reproducing lamps by their direct lines. In Fig. 3 only a single line connects the transmitting and receiving ends, and the output of each photocell is applied, in *sequence* (or *sequentially*) to that single line.

Practical Transmission

In present-day practical television transmission, only a single line and/or radio link connects the transmitting end to the receiving end. In consequence, ideas like Fig. 2 are out of the question, and we have to use a scheme which, like Fig. 3, enables the various parts of the picture to be presented to the coupling line sequentially. We do not, of course, use the Fig. 3 arrangement itself, but that which we *do* use has one or two points of similarity with that arrangement.

At the transmitting end of the television system the scene which is to be reproduced is focused by means of a lens system onto a plate in the television camera. An electron beam is also made to fall on this plate, and

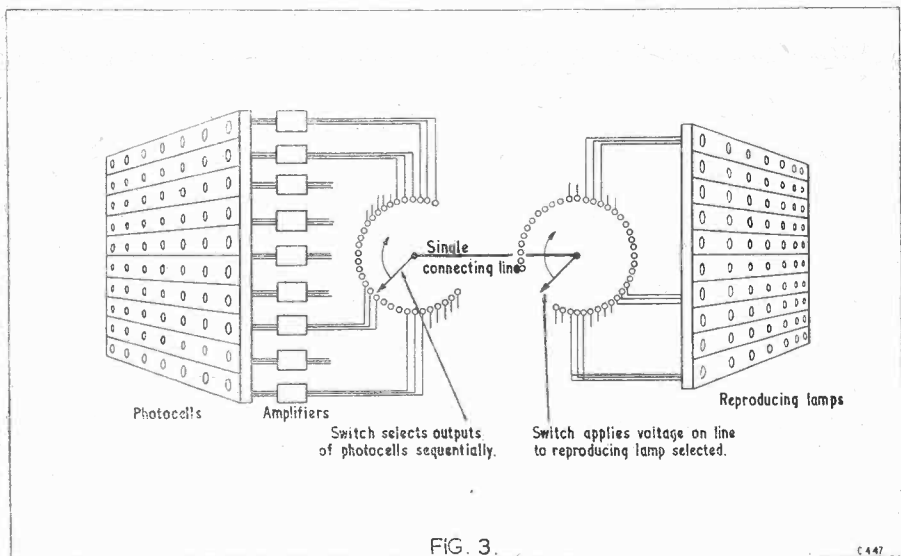

Fig. 3. Of the many practical difficulties involved in the arrangement of Fig. 2, one of the most obvious is the very large quantity of wires needed between the transmitting and receiving ends. If it were possible to have two rotating switches synchronised with each other, as shown here, only a single interconnecting line would be needed

it is focused such that it strikes the plate at a single spot having a very small area. The plate is coated with a photosensitive material and is connected to an external circuit in such a manner that a voltage is obtained which is proportional to the light intensity at the spot where the electron beam strikes. By means of suitable electrodes, or electro-magnets, it is possible to cause the electron beam to move (or to be deflected) along the plate—either to left and right or up and down—with the result that the path traced out on the plate by its “spot” can be made to look like that shown in Fig. 4. In this diagram we have the spot moving from left to right, thereby tracing out a number of lines. After tracing out each line the spot is made to move very quickly back to the left again, whereupon it commences to trace out a further line. (The quick movement back to the left is known as the *retrace*, or *flyback*, of the spot or beam). At the same time that it is moving from left to right and, quickly, back again, the spot is also caused to travel slowly downwards as well. Due to this downward movement the right-hand end of the first line is a little lower than its left-hand end. Since the flyback after completion of the first line is very short, the second line starts at a point which is only slightly lower than the end of the first. The

important thing to notice is that, since the second line is a little lower than the first, it corresponds to a part of the scene which is also slightly lower down. If we continue our process, with the electron beam moving from left to right and back again, as well as slowly downwards, we will eventually have covered the whole picture we want to transmit.

At the receiving end we can reproduce our transmitted picture with the aid of a cathode ray tube. In the cathode ray tube an electron beam is formed which similarly focuses on a screen in the form of a small spot. The screen is fluorescent, with the result that it emits light at the point at which it is struck by the electron beam. If we deflect the electron beam in the cathode ray tube in exactly the same manner as the beam at the transmitting camera is deflected, we will trace out exactly the same pattern on its screen as is traced out in that camera. If, next, we cause the strength of the electron beam in the cathode ray tube to be increased or decreased in proportion to the increase or decrease in voltage given by the transmitting camera, we will obtain increases and decreases in brightness on the cathode ray tube screen which correspond to those originally appearing on the plate of the camera. In other words, we will have reproduced on the screen of the

Fig. 4. A simple scanning system. The scene to be reproduced is focused onto a photosensitive plate as, also, is an electron beam. By making the point at which the electron beam strikes the plate trace out the path shown here, voltages proportional to the brightness level encountered by the electron beam "spot" may be transmitted to a remote reproducing device

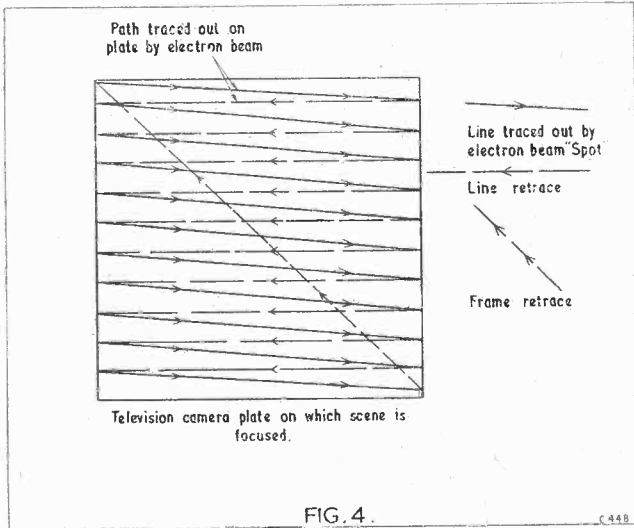

cathode ray tube the picture which was presented to the camera.

When we left the deflecting process in the camera, the electron beam was in progress of moving horizontally (in which case it traced out lines) and slowly downwards. The beam cannot, of course, carry on downwards for ever, so, when we feel that it has travelled far enough, we cause it to move very quickly upwards, whereupon it reaches the top of the picture and commences its slow downward motion once more.

It would be well at this point to introduce one or two important terms before proceeding further. Firstly, the process of deflection results in the beam *scanning* the picture, this term being employed whether the beam scans the plate in the camera or whether it scans the fluorescent screen in the cathode ray tube. The movement of the beam from left to right is known as *horizontal* or *line* deflection (or scanning) and the movement from top to bottom as *vertical* or *frame* deflection (or scanning). A complete *frame* has been

Fig. 5. An interlaced scanning pattern, in which the lines of one frame are interlaced in between those of the other

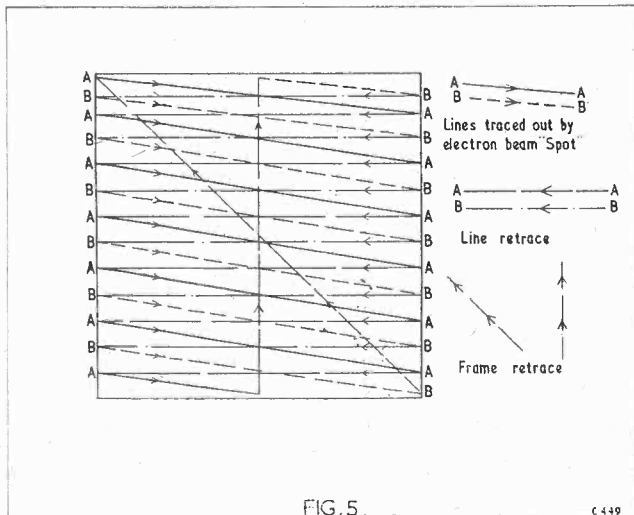

scanned when the beam has started from the top of the picture, reached the bottom, and been deflected to the top again. We referred earlier to "retrace" or "flyback." The quick movement of the beam from right to left after completing a line is known as the *line flyback*, and the quick movement from bottom to top after scanning a frame as the *frame flyback*. (The terms "horizontal" and "vertical" may be used here instead of "line" and "frame," as also may "retrace" instead of "flyback").

Interlacing

Although the simple scanning idea shown in Fig. 4 is quite capable of giving good pictures, it suffers from the fact that the whole process has to be carried out relatively quickly if the reproduced picture is to be free from flicker. For reasons which will be explained in a later article, we do not want to have the spot moving at a high speed if we can find some alternative means of overcoming the flicker nuisance.

The method normally used to overcome this difficulty is known as *interlacing*. Fig. 5 gives an illustration of the path traced out by the electron beam when it gives an interlaced picture. As will be seen, the electron beam first traces out a series of lines, exactly as before, and flies back to the top when the frame is completed. However, when it commences its second downward travel the lines it traces out lie in between the first series of lines. On completion of this second frame the spot returns to the top again and commences once more to follow the lines of the first frame. By using the interlaced method of transmission we obtain two separate frames, the lines of one being interlaced in between those of the other. A minor result of the interlacing technique is that the first line of one frame starts at the centre of the picture and not at the left-hand side. Similarly, a half-line appears at the bottom of the picture. The use of interlace gives the very considerable advantage of enabling the speed at which the lines of the picture are scanned to be reduced by approximately half for the same amount of freedom from flicker.

As we have just inferred, either of the interlaced scanning periods is known as a

frame. Two frames, when interlaced together, give us a *picture*. (American terminology is a little different, the two interlacing halves being known as *fields* and the interlaced whole as a *frame*.)

Frame Frequency

In order to prevent undesirable hum characteristics affecting the picture at the receiving end, it is common practice to make the frame repetition frequency equal to the mains frequency of the country in which the television system is to be used. When this is done the effect of hum becomes negligible since any distortion to picture shape, or movement of its position (the most difficult-to-clear results of hum) remain fixed in relation to the picture itself. When the frame frequency differs from the mains frequency the effects of hum trouble cause picture shape or position to be continually changing—an effect which is very noticeable. Hum difficulties of this nature are, incidentally; far less acute in modern televisions having efficient filter circuits than they were in more vintage receivers, but even so, it is still worth while taking advantage of a 1 : 1 relationship between mains frequency and frame repetition frequency. In Great Britain most households are supplied with electricity from the national Grid, and B.B.C. signals have a frame repetition frequency which is "locked" to the national Grid mains supply frequency. Thus, a very large percentage of British viewers are able to obtain a picture which is "locked" to the frequency of the a.c. mains fed into their homes.

In Britain, B.B.C. signals have a picture repetition rate of 25 per second, with a frame repetition rate of 50 per second. On the Continent and in Australia, where 50 c/s mains supplies are also used, the same applies. In America the common mains frequency is 60 c/s, which results in American television transmissions employing a standard of 30 pictures per second with 60 frames per second.

Next month

In next month's article we shall carry on to the composite television signal, illustrating the nature of picture information and the necessity for synchronising pulses.

A Useful Pocket Data Book

Have you data on fluorescent lamps and their circuits, on power cables, fuses, wire sizes, electric motors, coil winding, insulating materials, permanent magnets, drill sizes and thread dimensions? Would you like a complete list of British sound and t.v. stations, showing locations, frequencies and powers? Do you possess a map showing the field area of your local f.m. or t.v. station? All this is only a fraction of the information contained in over 100 pages in the front of the 1958 edition of Quinn's Electrical Engineering, Radio and Television Diary, published by H. O. Quinn Ltd., 151 Fleet Street, London, E.C.1.

The Cooper-Smith

TYPE BPI

HIGH FIDELITY AMPLIFIER

Part 2

by J. COOPER

THE MAIN AMPLIFIER

Assembly Instructions

Figs. 2 and 3 show the underside of the chassis, with one side laid flat so that the components fitted along this side can be clearly seen. Fit all the components except the group board. This should be done in the following order:

1. Valveholders, power socket and input socket. Make sure that these are the right way round. This is determined, in the case of the nine-pin holder, by the position of the groove in the spigot. Note the solder tag on V_1 and power socket.

2. Group board fixing bushes.

3. Transformers and choke.

The position of these is determined by the holes through which the leads are taken. These are directly under those in the components themselves. Check that the colours correspond to those on the diagram. The grommets may be fitted after the leads have been pulled through. Note solder tag on T_1 .

4. All the components along the side of the chassis.

Wiring Instructions

Important.—Do not use liquid flux such as Baker's Fluid. Only resin-cored solder should be used. This requires no other flux if the work is clean. After each joint has been made, give the wire a gentle tug to ensure that proper electrical contact has been made. Where several wires are taken to the same solder tag it is advisable to delay the actual soldering until they are all in position rather than to solder each wire separately. Complete the wiring shown on Fig. 2, commencing with the heater leads, which should be twisted as shown. Do not fit the group board at this stage.

Experience shows that most failures in amateur-constructed apparatus are due to errors in wiring, and we recommend that as each connection is made it is ticked off on the list below.

- T_1 : White pair to 2 and 7 on power socket
2 and 7 on power socket to 4 and 5 on V_4
and V_3 and to 4 and 9 on V_2 and V_1
(Join 4 and 5 on V_1 and V_2 .)
Black lead to 1 on fuse
Red lead to 4 on mains selector
Green lead to 3 on mains selector
Yellow lead to 2 on mains selector
Orange pair to 4 and 6 on V_5
Purple lead to 2 on V_5
Grey lead to 8 on V_5
White, brown and pink leads to S/T on T_1 (earth).
- T_2 : Black lead to 2 on speaker socket
Red lead to 1 on speaker socket
Blue lead to 7 on V_3
Purple lead to 7 on V_4
Green and yellow leads to 3 on speaker socket (see note below)
(Leave grey, pink and white leads until group board is fitted.)
- S_1 : 1 to 2 on V_1
2 to S/T on V_1
3 to input socket.
- V_1 : 7 to input socket
1 to 6.
- V_2 : Connect C_2 between 2 and 6, but do not solder yet
Connect C_3 between 1 and 7, but do not solder yet
- Power Socket: 3 to S/T (earth)
4 to 2 on mains socket
5 to 1 on mains selector
1 on mains socket to 2 on fuse.

Note. The secondary of the output transformer T_2 has two windings (not shown on

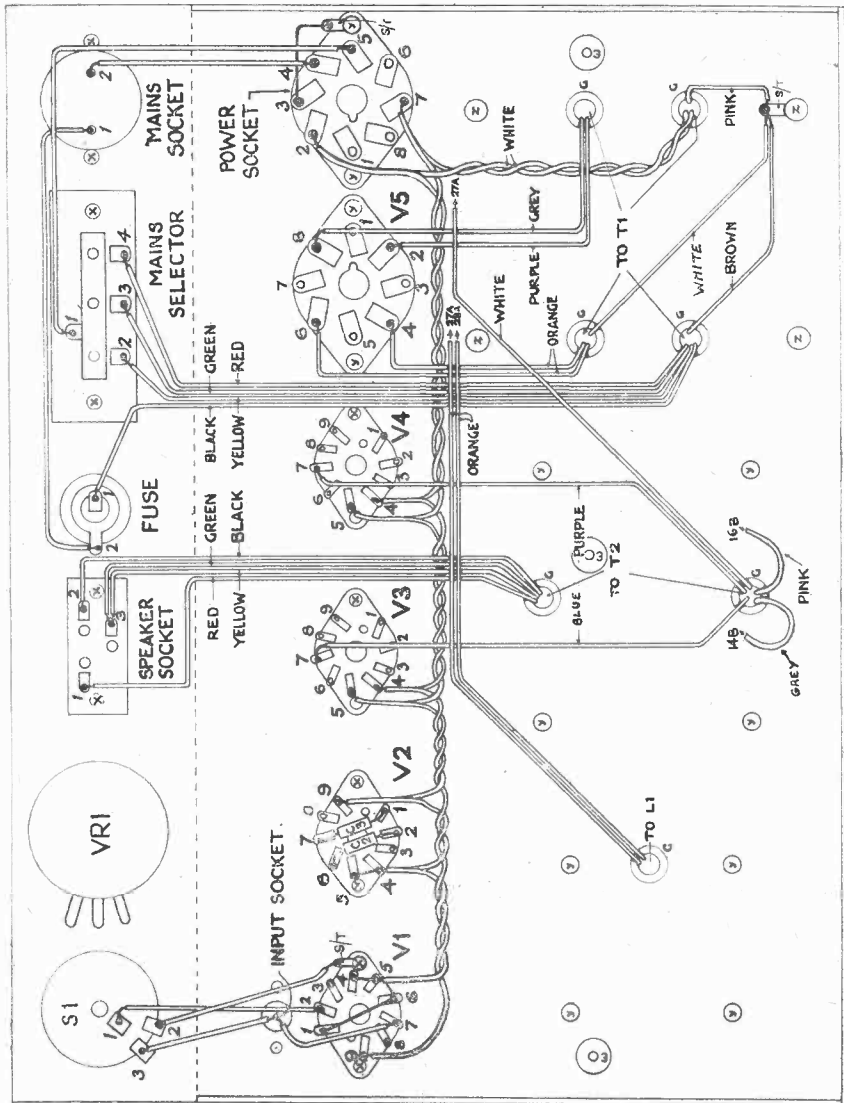

Fig. 2. Wiring and assembly, first stage

theoretical diagram) for series (15Ω) connection or parallel (3Ω) connection, tag 3 on the speaker socket being used solely as an anchorage. If 3Ω output is required, take the Yellow lead to tag 1 and the Green lead to tag 2. It will also be necessary to change feedback resistor R_8 to one of $10k\Omega$.

Now refer to Fig. 3. This shows the completion of the wiring after the group board has been fitted. The capacitors and resistors (except R_{11} and R_{12}) may be soldered to group board before fitting if desired. In this case, leave C_{10} off or it will not be possible to fit the screw which is underneath it.

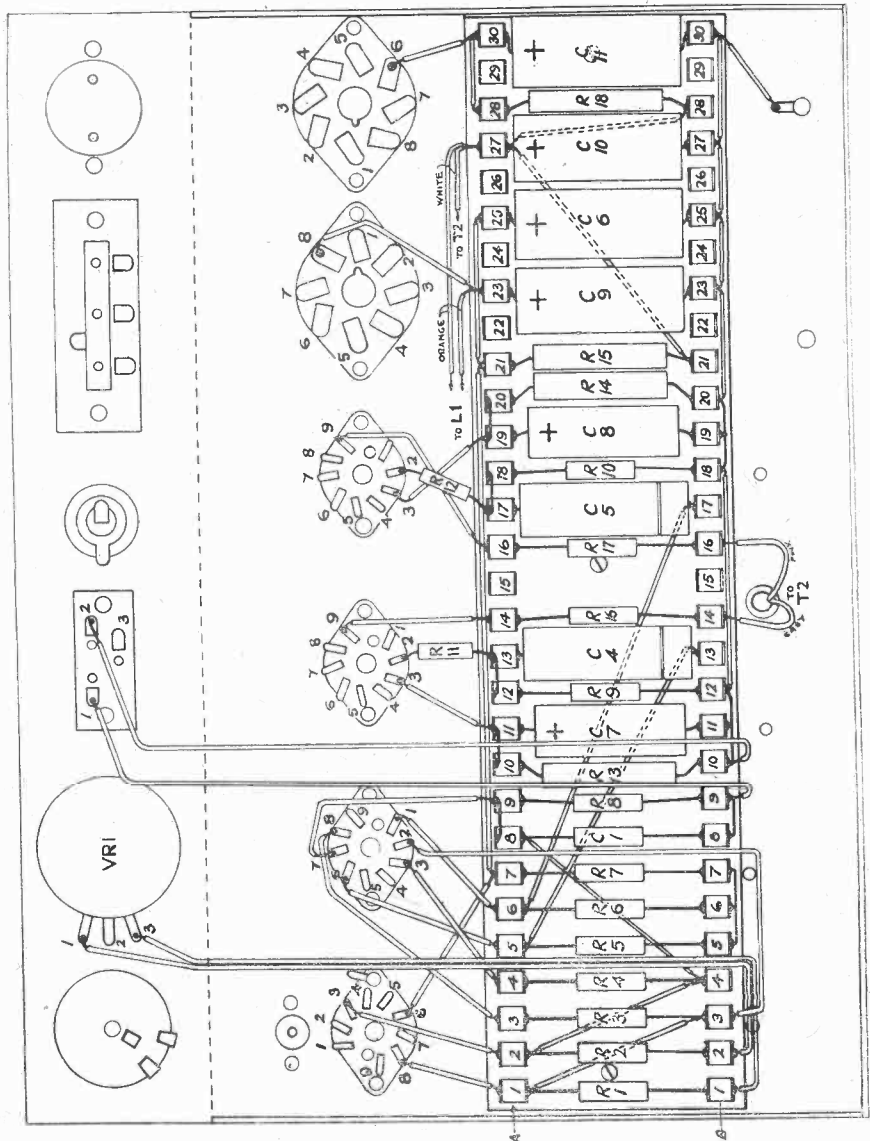

Fig. 3. Wiring and assembly, second stage

Wiring the Group Board

The group board solder tags are numbered on the diagram 1 to 30 A and B. Proceed to wire up as follows (these connections should be covered with sleeving):

- 1A to 3B
- 2A to 4B
- 28A to 30A
- 5B to 6B
- 23B to 25B
- 25B to 27B

- *4B to 8A
- 5A to 13B
- 6A to 17B
- 21B to 27A
- 27A to 28B
- 7A to 21A
- 21A to 25A
- 6B to 7B
- 8B to 9B
- 10B to 11B
- 11B to 12B
- 12B to 18B
- 18B to 20B
- 20B to 23B
- 27B to 30B
- 8A to 9A
- 10A to 11A
- 12A to 13A
- 17A to 18A
- 19A to 20A

* Leave sufficient wire to reach from 3B to 8A.

Next fit resistors and capacitors as follows (no sleeving required):

C ₁₁ from 30A (pos.)	to 30B
R ₁₈ from 28A	to 28B
C ₁₀ from 27A (pos.)	to 27B
C ₆ from 25A (pos.)	to 25B
C ₉ from 23A (pos.)	to 23B
R ₁₅ from 21A	to 21B
R ₁₄ from 20A	to 20B
C ₈ from 19A (pos.)	to 19B
R ₁₀ from 18A	to 18B
C ₅ from 17A	to 17B
R ₁₇ from 16A	to 16B
R ₁₆ from 14A	to 14B
C ₄ from 13A	to 13B
R ₉ from 12A	to 12B
C ₇ from 11A (pos.)	to 11B
R ₁₃ from 10A	to 10B
R ₈ from 9A	to 9B
C ₁ from 8A	to 8B
R ₇ from 7A	to 7B
R ₆ from 6A	to 6B
R ₅ from 5A	to 5B
R ₄ from 4A	to 4B
R ₃ from 3A	to 3B
R ₂ from 2A	to 2B
R ₁ from 1A	to 1B

When the group board is completed and fitted, finish wiring as follows:

1A to 8 on V ₁	7A to 6 on V ₁
2A to 3 on V ₁	9A to 7 on V ₂
3A to 8 on V ₂	11A to 3 on V ₃
4A to 3 on V ₂	14A to 9 on V ₃
5A to 6 on V ₂	16A to 9 on V ₄
6A to 1 on V ₂	19A to 3 on V ₄
23A to 8 on V ₅ and L ₁ (orange lead)	
27A to L ₁ (orange lead) and T ₂ (white lead)	
30A to 6 on power socket	
1B to 3 on VR ₁	
2B to 1 on VR ₁ (VR ₁ is automatically earthed through spindle)	
3B to 2 on V ₂	
9B to 1 on speaker socket	
10B to 2 on speaker socket	
14B and 16 to T ₂ (grey and pink leads)	
30B to S/T on T ₁ (earth)	
Connect R ₁₁ between 2 on V ₃ and A13	
Connect R ₁₂ between 2 on V ₄ and A17	
The Main Amplifier is now completed.	

Next Month: The Control Unit Mark 2.

SETTING UP AND CHECKING
(The Control Unit Mark 2 is required for this purpose)

Fit Fuse in Holder.

Check your mains voltage and set mains selector accordingly. With a resistance meter check that there is no resistance between 8 on V₅ and chassis (needle should kick over and return to zero). If there is a reading, this shows that the h.t. is shorting to earth and this should be corrected before proceeding further.

Connect Loudspeaker.

Insert valves. Fig. 2 shows their position,

and care should be taken to see that these are correct, also that the valves are placed in their holders properly, i.e. that the gap in the pins corresponds with the gaps in the holder. Check also that none of the valve pins are bent out of place.

The rectifier V₅ cannot be put in the wrong way without force. Plug in the output and power plugs from the pre-amplifier. Turn S₁ to the clockwise position. Switch on—allow 30 seconds for the valves to warm up. A red glow should be seen from the heaters when looking down at the valves. Turn S₃ to Radio position but do not connect a radio unit at this stage.

Turn volume control to full volume.

Touch the pin of IN (1) with finger, when a loud hum should be heard from the speaker. If this is present a signal source (radio, pick-up, etc.) may be connected and S₃ set to the appropriate position.

Adjust volume control for normal listening. Now turn S₁ anti-clockwise and adjust VR₁ for minimum volume. The amplifier is now balanced throughout, and when S₁ is returned to the clockwise position the amplifier should be functioning correctly.

If, however, this is not the case, carry out the following checks:

Checking for Faults

Note. The readings below were taken with an Avo 7 meter.

No Sound

Disconnect pre-amplifier output plug, and if a hum occurs in the speaker when a finger is placed on the pin of the input socket of the main amplifier, the fault is in the pre-amplifier. If not, carry out the following checks in the main amplifier:

Loudspeaker Connections.

Position of S₁ (should be anti-clockwise).

H.T. reading at pin 8 on V₅: 300–350 volts d.c. (all voltage readings should be taken with the negative lead of meter attached to chassis).

If the above are found to be correct, check the other h.t. points, i.e.:

27A—300–340V

5B—150–175V

7A—200V approx.

5A and 6A—75/100V

Pin 7 on V₃ and V₄—320V approx.

If these are correct, check grid bias voltages:

1A and 2A—2.5–3V

3A and 4A—7–10V

10A and 19A—10V approx.

If these readings are correct but there is still no sound, components and connections not covered by the above should be checked.

Distortion

Check grid bias voltages as above. If a howl is heard from the loudspeaker, reverse connections 1 and 2 on loudspeaker panel.

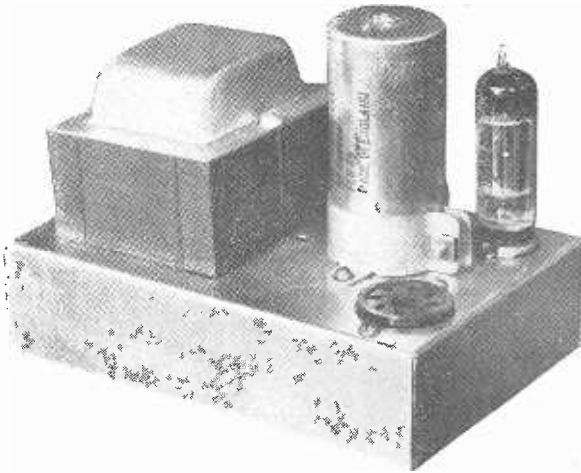

Mains Unit

for

FM Tuners

and other

Small Equipment

Described by **E. GOVIER**

THERE MUST BE MANY READERS OF *The Radio Constructor* who have constructed or acquired, within recent weeks, either the Jason, Denco, Gradient, or Osram 912+ FM Tuner units. Others again may be considering such a constructional project for the near future. Whichever of these excellent units is chosen and finally built, a power unit will be required as an external adjunct to the unit itself. It may be, however, that a small but efficient power pack is required for either general use within the workshop, i.e., as a bench power supply, or as a supply unit for a small item of test equipment such as a signal generator or even a pre-selector. The simple mains unit, about to be described, is primarily intended for any of the above requirements.

The circuit of the unit is that shown in Fig. 1, from which it will be seen that it is a perfectly standard design using the miniature 6X4 full wave rectifier (B7G base). Primary input tappings are provided at either 205 or 225V a.c. C_1 and C_2 , together with R_1 , ensure that the resultant d.c. is adequately smoothed and ripple free. The value of R_1 , the h.t. smoothing/dropping resistor, may be altered to suit various load requirements. The following readings are given under actual working conditions for the various units as shown. 912+ FM Tuner and the Denco 5-valve Tuner, $R_1 = 1k\Omega$, d.c. output to

tuner units being 235V at 50mA. Jason FM Tuner unit (Standard model) and Gradient FM Tuner, $R_1 = 3.5k\Omega$, d.c. output to tuner units being 235V at 24mA. Jason FM Tuner (Fringe Area model), $R_1 = 3.5k\Omega$, d.c. output to tuner being 215V at 28mA.

In all these cases, R_1 should have a rating of 5 watts.

Other output readings for various loads are as follows: $R_1 = 1k\Omega$ 5 watt rating, d.c. output 280V at 30mA. $R_1 = 1k\Omega$ 10 watt rating, d.c. output 210V at 70mA. $R_1 = 500\Omega$ 10 watt rating, d.c. output 275V at 55mA or 250V at 70mA, the latter current rating being the maximum rectified output obtainable from the 6X4 valve. The output conditions may, of course, be varied for other load requirements merely by altering the value of R_1 .

Generally speaking, therefore, the unit may be used for any equipment requiring from 200 to 270V at currents up to the maximum of 70mA d.c. The l.t. output is 6.3V at 2.9A.

The actual construction of the unit is extremely simple, and for the benefit of beginner readers who are about to construct their first a.c. mains power pack, brief constructional and wiring details are given herewith. The chassis is available ready drilled and punched, so no difficulty will be experienced here by those beginners who do

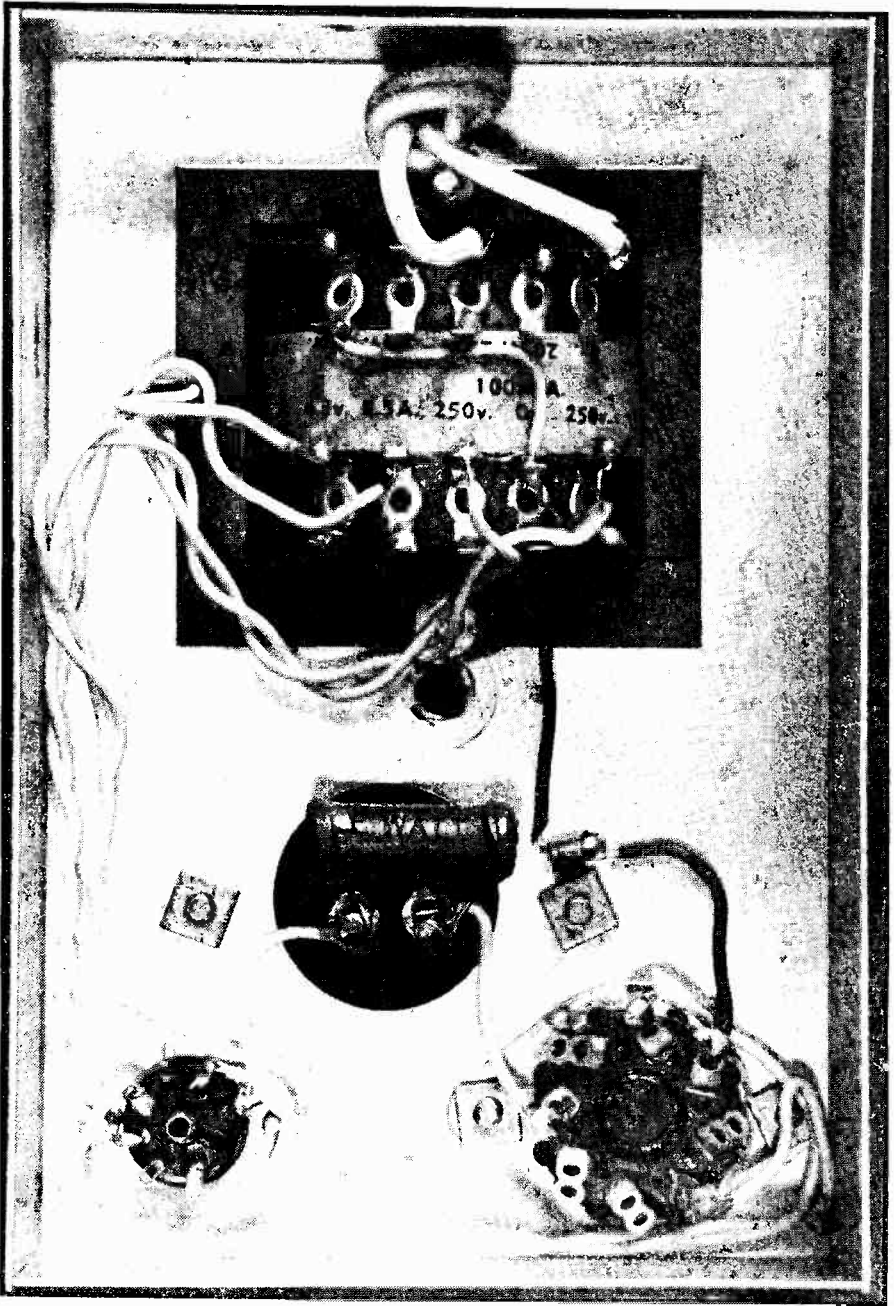

Underneath layout and wiring of FM Tuner Power Pack

not possess the necessary tools for this kind of work.

Firstly, secure into position, as shown in the accompanying photograph, the two valveholders, mains transformer and the condensers (both C_1 and C_2 are contained within the single metal case). Note particularly the orientation of the two valveholders. The octal valveholder is used as the output socket from the power unit to that item of equipment to be supplied with power; an old octal valve-base may be used as a plug for this purpose. Note that under the condenser securing nut nearest the octal holder an earthing solder tag is fitted. Insert the rubber grommet into position in the aperture provided on the chassis wall. Having mounted all the components as outlined above, wiring operations may now commence.

photograph should any doubt arise). From the right-hand connection of the transformer primary side (marked Scr) solder a small length of wire and join the other end of this to that connection of the transformer marked Ov on the secondary side. Dealing now with the secondary side of the mains transformer, solder one end of a length of PVC-covered wire to the left-hand connection marked 250v, and another similar length to the other tag marked 250v. Twist these two wires around each other and solder the other end of one to (a) pin 6 of the 6X4 valveholder (the smaller one) and (b) the remaining end to pin 1 of the same valveholder. Note: it does not matter which wire is connected to either pin 1 or 6—they may be interchanged at will. To that transformer tag marked 3.5A connect a wire, the other end of which is then soldered to

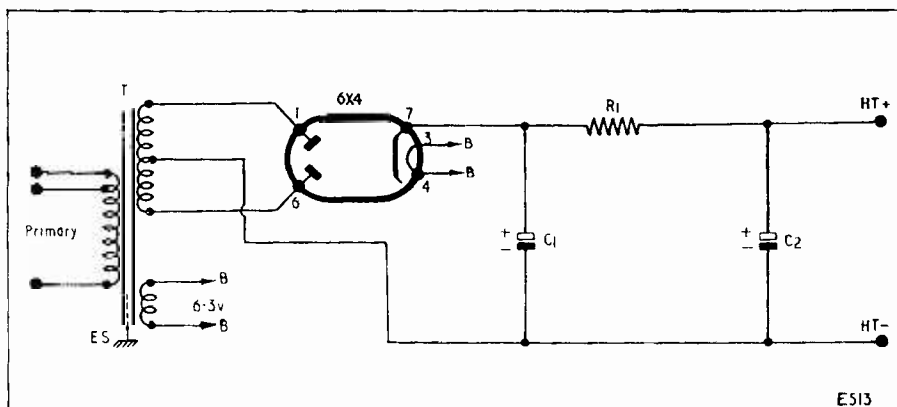

Component List

R_1 sec text
 C_1, C_2 16 + 16 μ F, 450V wkg, electrolytic
 Rectifier 6X4
 Mains transformer Sec. 250 0-250V at 100mA (Clyne Radio Ltd.)
 Chassis ready punched and drilled (Clyne Radio Ltd.)

International Octal valveholder
 B7G valveholder
 1 $\frac{3}{4}$ in condenser clip
 $\frac{3}{8}$ in rubber grommet
 Mains lead, connecting wire, solder tag, etc.

Pass the mains lead through the rubber grommet and, at some distance from the end, tie a knot as shown in the photograph. This ensures that no undue strain is placed on the two soldered connections to the mains transformer primary winding at a later date. Solder one of these leads (it does not matter which) to that transformer tag marked Ov. It is a good plan, before proceeding further, to so place the unit that the rubber grommet is nearest the reader; in this way the following instructions will be more easily followed. Next solder the remaining mains lead to that connection marked 225v (refer again to the

pin 3 of the 6X4 valveholder. With a further length of wire join that tag marked 6.3v to pin 4 of the 6X4 valveholder. Note: again both of these latter connections are interchangeable and the two wires should be twisted together before finally soldering into position. The last connection to the mains transformer is to that tag marked Ov on the secondary side. From this, solder a short length of wire the other end of which is connected to the earthed tag mounted under the condenser securing nut.

(continued on page 416)

radio miscellany

ONE OF THE PREREQUISITES OF A MONTHLY column such as this is that it should be topical. Unfortunately, the only topics occupying my thoughts in recent weeks have been sick-beds and fireside armchairs. Everyone is supposed to enjoy talking about their operations and symptoms; but nothing is more boring to other people, so I promise to lay off. The treatment was good while I prescribed for myself, cognac with a little lemon juice and honey. Its revitalising effect as it surges through your body is like a shot of pure d.c. on a dead circuit. Unfortunately, when the doctor came he switched me to an evil-looking mixture tasting like disinfectant lashed with vinegar, which made my inward circuitry feel like the bottom of a birdcage. Hence I have been a long while getting better, and at one period came perilously near to applying for life membership of the Radio Amateurs' Bedfast Club.

Well-meaning friends came along and decided no modern sickroom was complete without the "telly," and they started to instal a stand-by set which had been standing by for a long time. It worked—bags of volume—but there was only a quarter of an inch of picture. They tell me I kept deliriously repeating "Try the frame synchronising pulse separator valve." Eventually, to humour me, they did; and, poking about the inside of the set, they finally concluded it was a Mazda 6L1. They turned the house upside down looking for a spare. Of course they couldn't find one. My early associations with v.h.f. left me with a deep-seated prejudice against types with metal on the bases, and I usually avoid using them. With one particular make of valvholder I also found that despite the locating pimple it was still possible to get the valve in wrongly, which further deepened my little pet prejudice. Strangely enough, I have found these valves rather above the average in reliability, and I have never heard of a single instance of the glass around the pins fracturing—a not uncommon fault among baseless valves—but the prejudice remains and I don't stock spares.

Then I apparently feebly suggested that they looked around the circuit to see if there was another of the same type. There was, and on swapping them round the set behaved nor-

mally—whereupon they vanished in case something else went wrong. Actually I don't remember much about this incident. Maybe it was my subconscious self rising to a bit of trouble-shooting, but more likely it is a build-up by my so-called pals on some trivial incident. They appear to make a good story of it embellished with mimicry and imitation groans—and, of course, much more colourful language.

Sans Sound

Perhaps it is a little churlish of me, but I was not grateful for the bedside t.v. I find it difficult enough to put up with many of the programmes, even when I am fit and well. Apart from sport, there was little I enjoyed. Even the commentator at a football match maddened me with his inanities, and I began to wonder if he had ever played football himself. He kept calling bad passes clever interception and even worse, so I dispensed with the sound altogether. You must try it sometime. It's like looking at a match through a glass window, and if the camera work is good, as it was on this occasion, it is infinitely better than a lot of distracting and sometimes inaccurate chatter. One day I must get round to inventing a set which cuts out the commentator's burble yet leaves the noise of the crowd, cheering and jeering.

Years ago I discussed the idea of a "magnifier" to enlarge a part of the t.v. picture area to fill the whole screen. Unfortunately it could only be done to one size (to keep it in focus, etc.). Again it could only be the centre part, or some other special area, unless a considerable number of mechanical parts were fitted—at least as far as I could conceive it. What an opportunity for inventors! A commentator eliminator and a selected area magnifier to make life worth while for hard-to-please invalids.

Unsolicited Testimonial

Just before I was struck down I had completed an f.m. hi-fi receiver. This became my constant companion. The realism of the reproduction, despite the home-made (and acoustically unscientific) cabinet, is startling. I must confess the "contemporary furnishing design" cabinet was built to

ease my conscience over some attractive woodworking attachments I bought to complete my electric drill set. I have never been able to look at tools without being sorely tempted to buy 'em, even if I could put them to no foreseeable purpose. Every time I saw them in the workshop I felt a twinge at spending so many pounds and still leaving them lying idle. Hence the cabinet. Very "contemporary" with dual speakers so lost in the design that people have to look in the back to make sure just where they are located. The B.B.C. put on so many good sound programmes nowadays that having listened to them on f.m. hi-fi I have almost become an anti-t.v. fan.

Evidence of the realism of my new receiver came when a visiting female relative brought up my tea on a tray. There was a pause in the programme when she entered the room. After she advanced a few steps a very natural voice broke the silence to announce the next item. Looking round in alarm, she dropped the tray. Of course the female part of the family cattily aver, "She always was clumsy and probably tripped over a feather." As I was the only witness I am in the best position to judge why she dropped the tray. It was the realism of the voice coming from complete silence. Also would I not be the first to

The kindest advice I could give him was where to get a new one cheap, and warn him never to do it again!

He also brought along a pair of binoculars for which he had exchanged an expensive camera some years ago. I don't think he has ever found a use for them, but no doubt binoculars, for those who admire them, are nice things to own. Learning from Moscow Radio that the carrier rocket used to send Sputnik One on its way may shortly burn up, he polished up his binoculars in readiness. The broadcaster forecast it would produce a strong light that would be visible even on a sunny day. Checking his binoculars by scanning the horizon, he hit upon the uncompleted lattice mast, and he brought them along for me to see if I could guess what wealthy amateur was responsible for it. It certainly looks like a lattice mast, and if it is really for radio it is probably for some taxi-hire service. All the amateurs I know seem to have far too much difficulty in getting very much more modest affairs past stone-walling town planners.

I have been watching it for some days now, and work on it seems to be at a standstill. Excitement grew on the Saturday. If work started then, the chances that it was an amateur's week-end efforts would seem

centre tap . . . talks about items of general interest

complain of clumsiness seeing that most of the hot tea was slopped on me? True I didn't have to do any of the clearing-up (one of the advantages of being an invalid), but I consider it most unfair for the womenfolk to be catty every time I relate the incident to impress my visitors with the reality of this reproduction, especially as I am still too weak to argue it out.

Making Light of it

One minor diversion from my armchair convalescence has been a daily observation of what appears to be a lattice tower aerial mast going up on the horizon. A neighbouring enthusiast was the first to spot it. He has dabbled with radio since the crystal set days, but has never got beyond the stage of regarding radio receiver building as an adult form of Mecanno construction. When, to his utter astonishment, his sets don't work he brings them to me to have a look-see. This time he called round about his battery charger. When it failed to charge he took the metal rectifier to pieces to see why. He brought all the bits and pieces in a little box and wanted me to tell him in what order they should be re-assembled.

brighter. Two week-ends have now passed and nothing has happened. Maybe it isn't for an aerial at all. I was caught in a similar way about 18 months ago when driving along the London-Folkestone road near Farningham. In the distance I spotted a magnificent tower—a sixty-footer at least, with a multi-element beam being put across the top. Eyes skyward, I trod on the gas—only to find it was to be used to suspend a couple of ugly-looking lamps to illuminate a roundabout!

Loose Ends

My friend (of the binoculars) asks why this column has wasted space on a quest for an ideal test record. Surely, he says, it is better to use a record one really knows by having heard it many times and on different amplifiers. I heartily agree it might sound *different* on each of his bits-and-pieces amplifiers, each with its own combination of distortions. An astonishing number of people, too, don't even notice loudspeaker resonances that they have grown accustomed to hearing. Perhaps after all they get just as much pleasure at listening to something they call pleasing as the ultra-critical do out of their hi-fi. (cont. p. 416)

The SATELLITE Pre-Tuned FM Unit

Described by **D. PETERS**

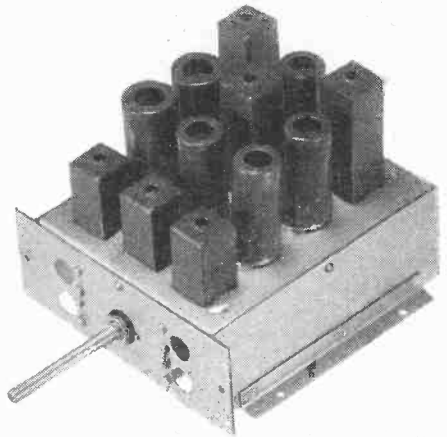

This article gives details of the operation and construction of a sensitive pre-tuned f.m. tuner unit. A particularly attractive feature of the tuner is provided by the inclusion of automatic frequency control.

ALTHOUGH V.H.F. TRANSMISSION HAS NOT as yet reached the stage where complete country-wide coverage is provided, it has already been "accepted" by the general public as an integral part of normal domestic listening. One or two minor disadvantages have become evident since f.m. was first introduced, but these have been mainly due to what the writer feels is lack of experience—largely on the part of the layman—with the new medium. Typical of these disadvantages have been such things as multi-path propagation, oscillator drift, and reputed difficulty of tuning. Multi-path propagation in fringe areas is liable to cause distortion, and is almost always caused by the use of an inefficient aerial such as that provided inside the cabinet by some commercial receiver manufacturers. The provision of a more efficient aerial, even if this only consists of a simple dipole in the same room as the receiver, usually effects a cure. Oscillator drift has also given trouble now and again, and is particularly difficult for the layman, who has had previous experience of medium and long wave radio reception only, to understand. Just as difficult for the non-technical person to appreciate is the necessity for

correctly tuning an f.m. receiver. It frequently happens that a receiver is tuned to the extreme edge of its discriminator characteristic, whereupon low modulation signals are reproduced tolerably well whilst high modulation signals suffer excessive distortion.

In view of these remarks it is pleasing to record the introduction of a new home-constructed f.m. tuner unit which should go quite a way to overcome the last two difficulties just described and which may even help to provide an economic answer towards alleviation of the first. The new Osrom f.m. tuner is a sensitive unit which employs automatic frequency control and pre-selected station switching. In consequence, therefore, the two major bugbears of difficulty of tuning and oscillator drift are entirely eliminated. With this tuner it is necessary merely to set the station selector switch to the desired programme, whereupon not only is this at once correctly tuned in but it also stays that way, any tendency to drift being overcome by the a.f.c. circuit. So far as multi-path propagation is concerned, avoidance is entirely a function of correct siting of the aerial. However, due to the sensitivity of the Osrom unit, it may be found that an economic

compromise between aerial performance and prevention of m.p.p. may more readily be found.

Other features of the Osmor unit are a low-impedance a.f. output from a cathode follower, and a semi-limiter preceding the ratio discriminator.

V_1 functions as the r.f. amplifier, its anode coupling into coil L_3 via C_5 . Coil L_3 is tuned by whatever capacity is connected across it by switch $S_{1(a)}$. In position 'A,' $S_{1(a)}$ connects a fixed condenser, C_6 , across the coil; whilst in positions 'B' and 'C' it similarly connects trimmers CT_1 and CT_2 . The reason

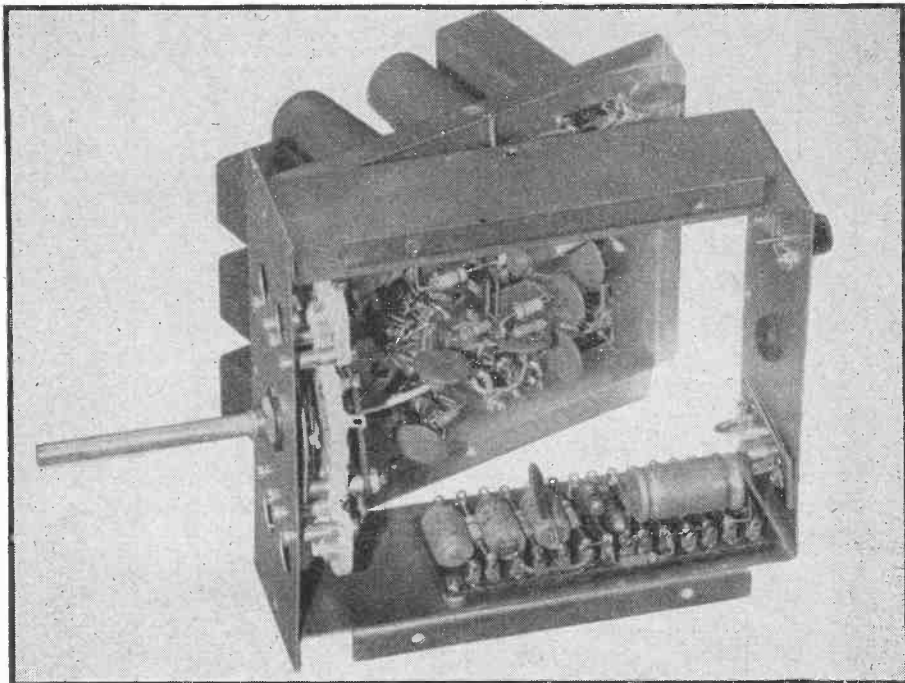

Frame and top of chassis (detachable). Note ceramic air-spaced trimmers and switch, also pre-assembled panel which is available

Circuit Design

The circuit of the tuner unit accompanies this article as Fig. 1. Commencing at the aerial input socket, it will be noted that the first tuned circuit is provided by the secondary of the r.f. transformer L_1-L_2 , this secondary being paralleled by C_1 . The impedance presented to the aerial socket by the primary is, conventionally, 75 ohms; and unbalanced coaxial cable may be used for the aerial feeder. The core of L_1-L_2 is adjusted so that its secondary tunes to the centre of the band of frequencies it is desired to receive. Due to the damping caused by the aerial, the response of the first tuned circuit is sufficiently flat to enable stations on either side of the central frequency to be received with negligible attenuation.

for the particular arrangement of trimmer switching employed here is that the core of L_3 may be adjusted in conjunction with the fixed condenser in position 'A,' whereupon CT_1 and CT_2 are required only on positions 'B' and 'C.' By this means only two trimmers are required, and cost and chassis space are consequently saved. The signal voltage appearing across L_3 is applied, via C_7 , to the grid of the additive mixer V_2 .

Also fed to this grid is the output from the oscillator $V_{3(a)}$, this being applied via condenser C_{20} . The oscillator operates in a conventional "e.c.o.-type" Hartley circuit, the capacity tuning the oscillator coil, L_4 , being selected via switch $S_{1(b)}$. $S_{1(b)}$ selects one fixed condenser and two trimmers in the same manner, and for the same reason, as

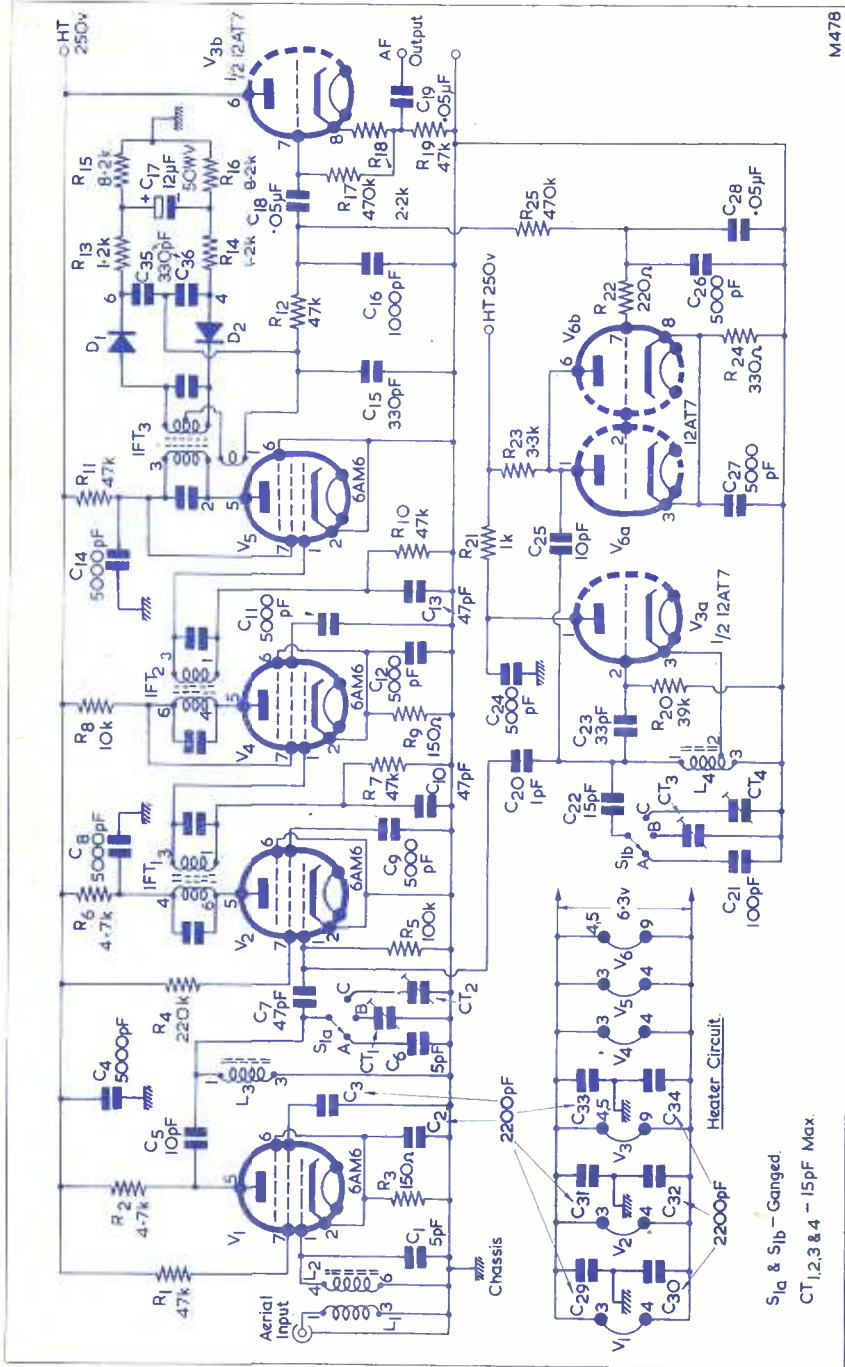

Fig. 1. The Satellite pre-tuned FM unit. (Note: C₂₁ should read 10pF, not as shown.) The values of condensers fitted inside i.f. transformers are not shown

does S_{1(a)}. The reactance valve V₆ effectively connects across the oscillator as well. The operation of this valve will be discussed later.

The i.f. output from the mixer is applied to the first i.f. transformer IFT₁ and, thence, to V₄. V₄ is a straightforward i.f. amplifier and feeds, in its turn, into the second i.f. transformer.

The secondary of IFT₂ is connected to the limiter V₅. This valve is biased back by the rectified signal voltage built up across the grid leak and condenser R₁₀, C₁₃, with the result that high level signals cause the valve to work beyond cut-off. In this condition any amplitude modulation which may appear becomes largely suppressed. The semi-limiting action given by V₅ is, of course, additional to the limiting which is provided automatically by the ratio discriminator itself.

The ratio discriminator coil IFT₃ is connected in the anode circuit of V₅ and it follows normal and well-established practice. A balanced stabilising network is employed; this statement inferring that the chassis connection is taken to the centre point of the resistive load, R₁₅, R₁₆, which shunts the stabilising condenser, C₁₇. A balanced discriminator circuit has a slight advantage over an unbalanced circuit (wherein one side of the stabilising condenser connects to chassis) insofar that it provides somewhat better a.m. limiting; but the main reason for its use in this particular unit is that the average d.c. potential available at the audio take-off point is zero with respect to chassis when the input frequency is at the centre of the discriminator characteristic. Deviations of input frequency to either side of centre then cause this d.c. potential to go positive

COMPONENT LIST
SET OUT WITH EASY REFERENCE TO FIG. 1

Resistors (all $\frac{1}{2}$ watt unless otherwise stated)	Condensers—continued
R ₁ 47k Ω	C ₁₄ 5,000pF disc
R ₂ 4.7k Ω	C ₁₅ 330pF
R ₃ 150 Ω	C ₁₆ 1,000pF
R ₄ 220k Ω	C ₁₇ 12 μ F 50V wkg electrolytic
R ₅ 100k Ω	C ₁₈ , C ₁₉ 0.05 μ F paper
R ₆ 4.7k Ω	C ₂₀ 1pF
R ₇ 47k Ω	C ₂₁ 10pF
R ₈ 10k Ω 1 watt	C ₂₂ 15pF
R ₉ 150 Ω	C ₂₃ 33pF
R ₁₀ 47k Ω	C ₂₄ 5,000pF disc
R ₁₁ 47k Ω 1 watt	C ₂₅ 10pF
R ₁₂ 47k Ω	C ₂₆ , C ₂₇ 5,000pF disc
R ₁₃ , R ₁₄ 1.2k Ω	C ₂₈ 0.05 μ F paper
R ₁₅ , R ₁₆ 8.2 k Ω high stability	C ₂₉ , C ₃₀ , C ₃₁ , C ₃₂ , C ₃₃ , C ₃₄ 2,200pF
R ₁₇ 470k Ω	C ₃₅ , C ₃₆ 330pF
R ₁₈ 2.2k Ω	CT ₁ , CT ₂ , CT ₃ , CT ₄ 15pF trimmer
R ₁₉ 47k Ω	
R ₂₀ 39k Ω	Valves
R ₂₁ 1k Ω	V ₁ , V ₂ , V ₄ , V ₅ 6AM6 Brimar
R ₂₂ 220 Ω	V ₃ , V ₆ 12AT7 Brimar
R ₂₃ 3.3k Ω	
R ₂₄ 330 Ω	Coils
	L ₁ , L ₂ Aerial coil type QAFM, Osmor
	L ₃ Interstage coil type QRSW, Osmor
	L ₄ Oscillator coil type QOSW, Osmor
	IFT ₁ , IFT ₂ 10.7 Mc/s i.f. transformer type QIFM, Osmor
	IFT ₃ Ratio coil type QICD, Osmor
Condensers (all 350V wkg ceramic, unless otherwise stated)	
C ₁ 5pF	Miscellaneous
C ₂ , C ₃ 2,200pF	1 2-pole 3-way ceramic switch
C ₄ 5,000pF, disc	1 Coaxial socket
C ₅ 10pF	1 Output socket
C ₆ 5pF	4 B7G valveholders with screens
C ₇ 47pF	2 B9A valveholders with screens
C ₈ , C ₉ 5,000pF, disc	1 Punched chassis, Osmor
C ₁₀ 47pF	Nuts, screws, coaxial cable, tag-strips, etc.
C ₁₁ , C ₁₂ 5,000pF disc	
C ₁₃ 47pF	

or negative as applicable, thereby providing the control needed by an a.f.c. system.

In Fig. 1 the a.f. take-off point appears at pin 1 of IFT₃ (i.e. at the lower end of the tertiary winding), whereupon R₁₂ and C₁₆ perform the dual function of r.f. decoupling and a.f. de-emphasis. The a.f. is then applied, via C₁₈, to the grid of the cathode follower V_{3(b)}, across whose cathode load, R₁₉, the output voltage finally appears.

denser C₂₆ provides a low impedance path to chassis for any v.h.f.—or, for that matter, i.f.—voltages which may also be present. V.H.F. voltages will appear on the grid of V₆ and are partly filtered by R₂₂ in company with C₂₆.

The situation now arises whereby a steady d.c. potential which varies according to frequency deviation at the discriminator coil is applied to the grid of the reactance valve.

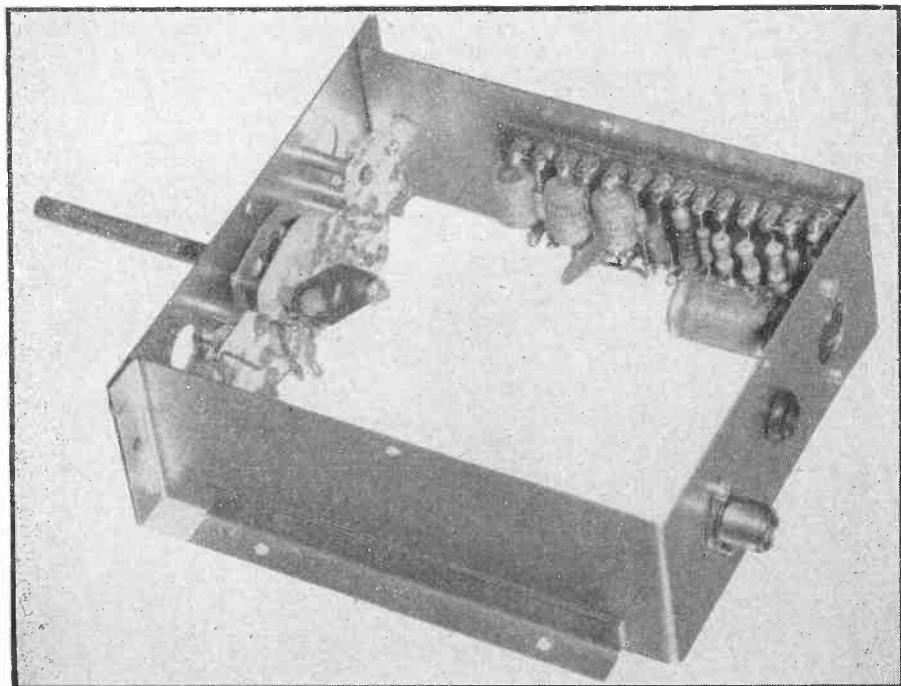

Frame of chassis with top removed

The A.F.C. Circuit

The a.f.c. circuit employed in the tuner is of interest, since it successfully takes advantage of quite simple techniques. As was mentioned above, a d.c. potential varying about zero appears at the a.f. take-off point of the ratio coil. In Fig. 1, this potential, after filtering by R₁₂, C₁₆, is further integrated (i.e. "smoothed") by R₂₅ and C₂₆, C₂₈ in parallel. The reason for using two condensers in shunt at this point of the circuit is that it is necessary to decouple both a.f. and r.f. to chassis. The 0.05 μ F condenser C₂₈ prevents a.f. voltages being applied to the grid of the reactance valve V₆, whilst the ceramic con-

Although it is helpful to consider the reactance valve as a single triode, it consists, in practice, of a double triode—V_{6(a)} and V_{6(b)}—whose two halves are strapped together. This combination is capable of exerting a greater degree of frequency control than would be given by a single triode of the same type. The impedance appearing between cathode and anode of the reactance valve is connected to the oscillator coil in series with condenser C₂₅, and is largely resistive in character. When the potential at the grid of V₆ is varied this resistive impedance varies also, thereby altering the total impedance across the oscillator coil and changing its resonant frequency.

A somewhat crude way of looking at the action of V_6 would be given by saying that, when its grid voltage is positive, the valve offers low resistance and C_{25} has a large effect on oscillator coil tuning; whilst, when the grid of V_6 is negative, the valve offers high resistance and C_{25} has only a small effect on oscillator coil tuning.

Although the impedance offered by V_6 is largely resistive, there is a certain amount of

Construction

The construction of the tuner should prove to be a relatively simple operation, and a ready-punched steel chassis is available. Component layout below the chassis is illustrated in Fig. 2, this diagram giving a view in which the front and rear panels are "opened out." Fig. 2 also indicates the pin numbers of valves and coils, thus enabling these to be fitted in their positions with

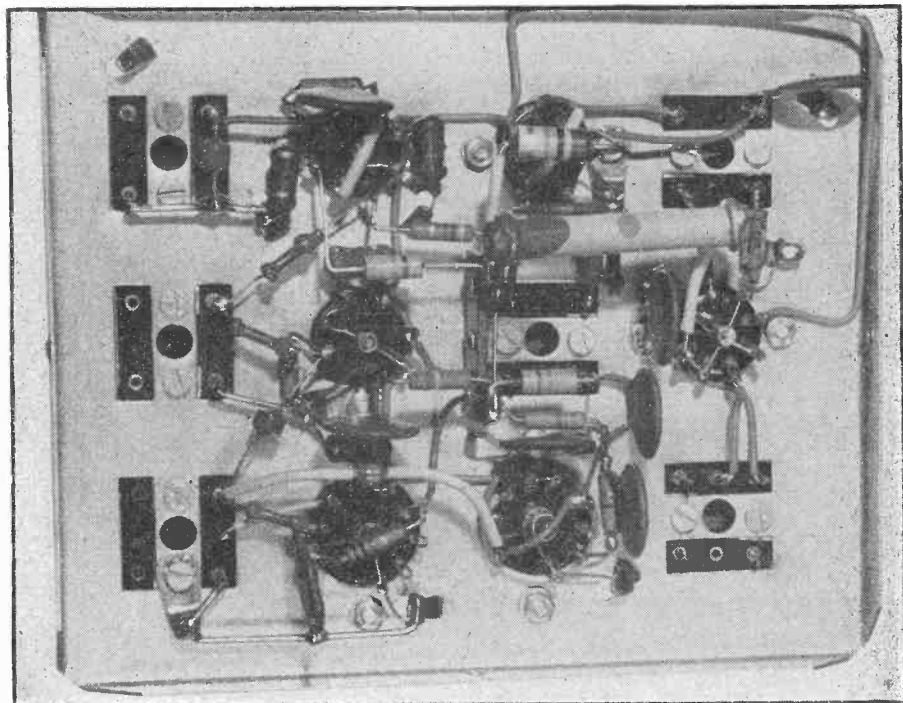

Top of chassis, from below

capacitive reactance (notably given by the C_{ag} and C_{ak}) which could also have some effect in the circuit. This capacitive reactance may vary with varying grid voltage, but it is doubtful if its effect would be as great as that given by the varying resistive impedance.

As will be readily gathered, it is important to ensure that the d.c. control voltage applied to the reactance valve is correctly phased in relation to the frequency shift which is desired. If the potential were incorrectly phased the a.f.c. system would tend to detune rather than tune the receiver. In the unit discussed here incorrect phasing should not occur, since the ratio discriminator diodes, D_1 and D_2 , are wired up by the manufacturer inside the discriminator coil can.

correct orientation. For the sake of clarity the heater wiring to valves other than V_5 is not shown. All the valve heaters should be connected in parallel, the wiring being well twisted together. The heater circuit is intended for operation from a 6.3 volt supply earthed at the power pack, and no chassis connection for the heater wiring is provided at the tuner unit chassis. The h.t. negative line is earthed at the tuner unit chassis in conventional fashion.

As some of the wiring may be partly hidden by the station selector switch and the tag-strips which mount on the sides of the chassis, it would be advisable to fit these components at a fairly late stage in the process of construction. Any components which are fitted

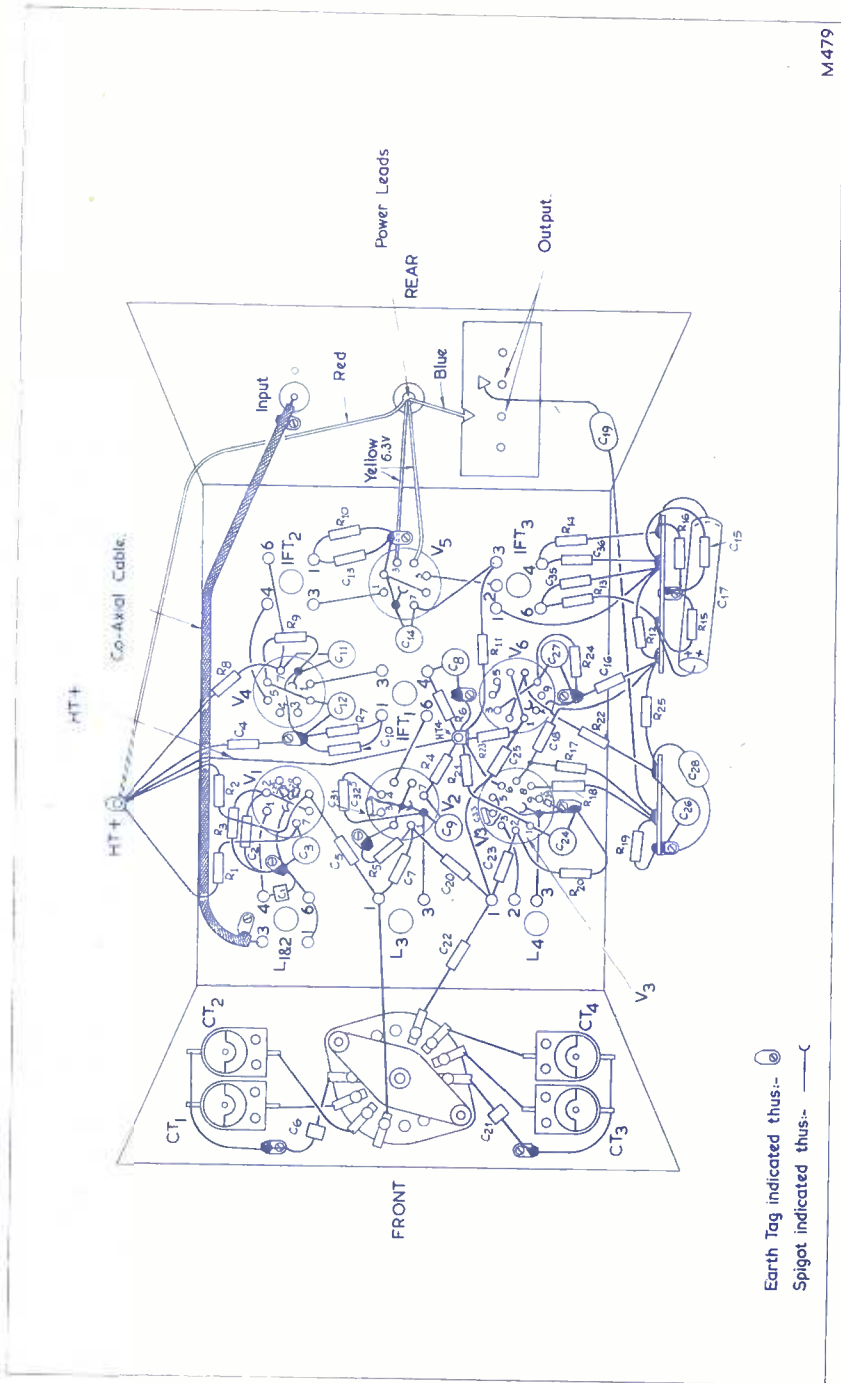

M479

Fig. 2. Under-chassis layout of the tuner

to these tag-strips may then be soldered in at this later stage.

Due to the frequencies at which the unit works, short leads to all components are essential.

It is obviously necessary to ensure that all joints are carefully and reliably soldered. Due to the compact nature of the tuner it would also be desirable to fit sleeving to any component lead where the possibility of accidental short-circuit exists. Few of the components need to be handled with any more care than is normal, but it would be advisable to keep the vanes of the four trimmers in the closed position until they have been mounted and wired up. This precaution will reduce the risk of their being accidentally bent during assembly.

Alignment

Almost all the v.h.f. f.m. transmitters at present in service in the U.K., or envisaged for the future, operate on frequencies such that a particular district receives the Light Programme 2.2 Mc/s below the Third Programme, and the Home Service 2.2 Mc/s above. Because of this it is possible to refer, in the following alignment instructions, to the "lower frequency station," the "centre frequency station," and the "higher frequency station," with the assurance that these descriptions will almost always correspond to the Light, Third and Home Programmes in that order. In areas where this frequency relationship does not entirely apply, the constructor may append these descriptions to the transmissions available in his own particular case.

Before signal frequency alignment is commenced it is necessary, however, to primarily adjust the i.f. transformers. For this purpose a high resistance voltmeter switched to read around 50 volts f.s.d. should be connected, observing polarity, across C_{17} , and the tuner unit switched on and allowed to warm up. The unit should be allowed to reach full operating temperature before making any adjustments, this process taking some twenty minutes or so. During alignment, the a.f.c. circuit should be put out of action by temporarily connecting the junction of R_{22} and R_{25} to chassis with a short length of wire.

An unmodulated signal generator set to 10.7 Mc/s is next applied to the grid of V_5 , and the top core of IFT_3 adjusted for maximum deflection of the meter. The signal generator is then connected to the grid of V_4 , whereupon both cores of IFT_2 are adjusted for maximum meter deflection; and to the grid of V_2 , whereupon both cores of IFT_1 are similarly adjusted. The voltmeter is then removed from C_{17} and re-connected

across C_{15} , after which the bottom core of IFT_3 is set up for zero deflection. The final setting of this bottom core should be such that turning it slightly on either side of its correct position causes the meter needle to swing across the zero point on its scale. During i.f. alignment the signal generator output should be attenuated as necessary to prevent overloading.

After the i.f. stages have been aligned, the signal generator may be removed and an appropriate aerial connected to the input socket of the tuner. It may prove helpful at this point to connect the output of the unit to a suitable a.f. amplifier so that stations received may be identified. Switch S_1 should be set to position 'A' and the core of L_4 carefully adjusted until the higher frequency station is received. The final adjustment of this core will be that which causes the meter (still connected across C_{15}) to give zero reading; deviations of the core about its correct setting causing the needle to swing across the zero mark. The meter should then be transferred to C_{17} and the core of L_3 adjusted for maximum reading.

Switch S_1 should next be set to position 'B,' whereupon trimmer CT_3 is adjusted for reception of the centre frequency station. The final setting of this trimmer is that which causes zero reading in the meter when the latter is connected across C_{15} . The meter should be returned once more to C_{17} , and trimmer CT_1 adjusted for maximum reading. Since the receiver is now switched for reception of the centre frequency station, the core of L_1 - L_2 may also be aligned. This core should be adjusted for maximum meter reading.

Basically the same procedure is employed with switch S_1 in position 'C.' First of all, trimmer CT_4 is adjusted to receive the lower frequency station, its final setting being that which causes zero reading in the meter when connected across C_{15} . The meter is next re-connected to C_{17} and trimmer CT_2 set up for maximum deflection.

It would be worth while to finally check the r.f. alignment by running through the above procedure again, after which the unit is completely set up. All that remains is to disconnect the temporary lead connecting the junction of R_{22} and R_{25} to chassis in order to bring the a.f.c. circuit into operation, and the tuner unit is ready for use.

Ancillary Equipment

Before concluding, a brief description of equipment ancillary to the tuner should be given. This will concern the power unit and a.f. amplifier with which the unit is to operate.

(continued on page 416)

Technical Forum

Flyback Blanking

A CONSTRUCTOR HAVING COMPLETED A television receiver will often sit back for a time and regard the picture of his handiwork with some degree of satisfaction. But usually this satisfaction begins to wear a little thin after a time as minor defects in the picture become obvious, and so it is that in spite of protests from the family the set has to have certain modifications made to it. If the work can be done quickly, viewing is restored before the protests become serious, and quite frequently the results of the work are appreciated by all and the satisfaction obtained from a job well done again prevails. A defect which exists in many receivers but which may only become noticeable after a period of viewing is associated with excessive attenuation of the d.c. component of the video signal. When such attenuation exists the receiver will exhibit certain quite unmistakable characteristics.

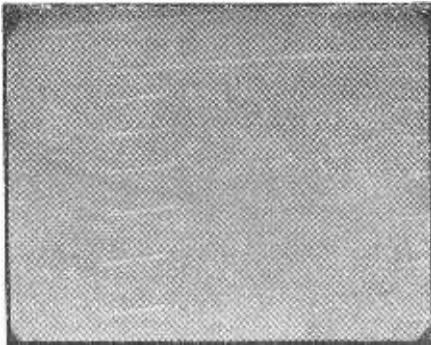

Fig. 1. Synchronised raster showing half-line pulses

For example, at the optimum setting of both the contrast and brightness controls a picture having equal light and dark areas will appear to be satisfactory. When the scene

changes to one in which the majority of the area is white, the black level will fall and the detail in the grey areas will be lost. Conversely, on very dark scenes the flyback lines will become visible, particularly the half-line pulses radiated during the frame blanking period. It follows that during the short intervals when no video information is being transmitted the screen will appear as in Fig. 1, with these flyback lines clearly visible. It will be noted that the frame flyback pattern (the short half-line pulses) is displayed at a greater intensity than the scanning lines. On certain pictures which are largely black or dark grey these flyback lines may become visible and can be very distracting to the viewer.

The D.C. Component

This type of defect is associated with the d.c. component in the video stage, and it may be of interest to the reader to digress a moment to consider the conditions which produce it. The video signal is unidirectional and thus has a mean value which will depend primarily upon its amplitude. For the signal to retain its characteristic the d.c. component must be preserved with a reasonable degree of accuracy, otherwise the fluctuating mean level will vary the black level. Consider first a series of black lines, that is lines which contain no picture information, such as are shown in Fig. 2a. If the receiver is being set up on a blank raster of this nature it would be necessary to adjust the brightness control so that the picture tube was just cut off and displayed no raster. Then when vision modulation is transmitted, the signal will appear as in Fig. 2b, from which it will be seen that the mean level has risen in value but the black level has, of course, remained constant. Under ideal conditions the tube should still be just cut off when the modulation is at the black level and the vision content can then be displayed on the screen at the correct level of light and shade. However, for many reasons the black level may not be correctly maintained due to the attenuation, or in some receivers the complete loss, of the d.c. com-

ponent of the signal. If this component is entirely eliminated, the cut-off level of the picture tube will rise to the mean level of the vision signal (Fig. 2b). This means that that part of the vision modulation falling below the "mean level" line will be lost, and with it much of the detail in the grey sections of the picture. This condition is sometimes referred to as "compression in the black areas of the picture."

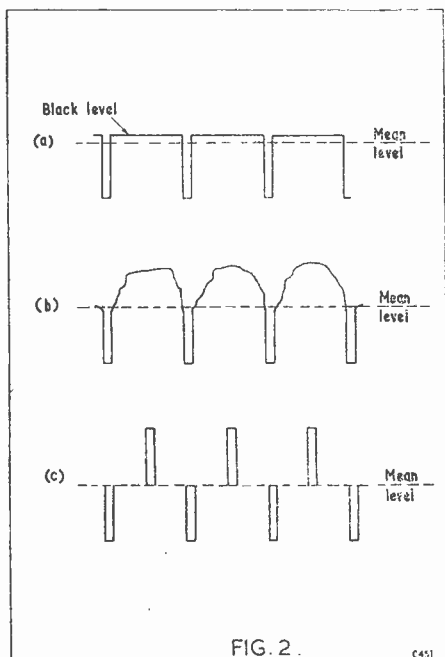

Fig. 2. Showing how the level changes with picture content

When the conditions which have just been described occur the viewer may well readjust the brightness control on the receiver so that the detail in the grey areas again becomes visible, and the picture will then appear with the correct range of tones between black and white. But this condition prevails only whilst the mean level of the picture remains unchanged. Considering, for example, a very dark screen which has a white line down its centre, the vision signal for one line would look like that in Fig. 2c, and the mean level would have fallen to that shown by the dotted line. This would bring the scanning lines up to the point where they become just visible and the frame flyback would stand out at a

greater intensity. The frame flyback appears as the half-line pulses which are brighter than the scanning lines because they are superimposed on the top of them. The distracting effect of these flyback lines can be substantially reduced by a blanking circuit.

Frame Flyback Blanking

To discover the cause for the attenuated d.c. component and rectify the matter is not necessarily the best solution, as it is very probable that some attenuation has been built into the receiver to mask the detrimental effects of poor e.h.t. voltage regulation, aeroplane flutter, or a mean level a.g.c. circuit. Some form of frame flyback suppression is usually adopted, its purpose being to blank the tube out during the frame flyback time and thus eliminate the half-line pulses which can appear across the raster as in Fig. 1. If, as is usually the case, the picture tube is cathode modulated, the blanking pulse is fed into the grid; but, conversely, where grid modulation is used the blanking is fed to the cathode. In the circuit diagram of Fig. 3 the

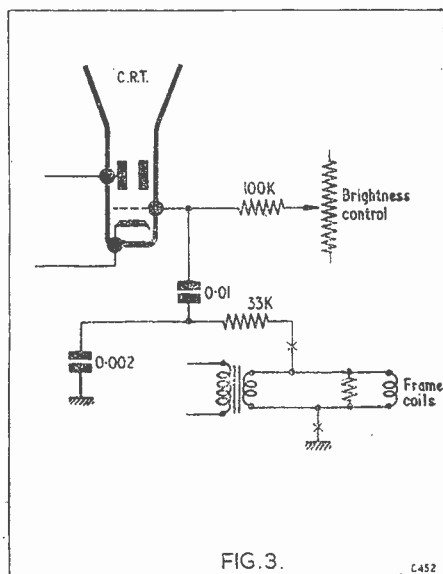

Fig. 3. Frame blanking circuit for a t.v. receiver

more general arrangement using cathode modulation is shown, in which case a negative-going pulse is required to be fed on to the tube grid. This pulse is obtained from the frame timebase, and a variety of connections are possible depending upon the circuits

which are employed. Perhaps the best general example is that in which the blanking pulse is obtained from the secondary of the frame coil matching transformer. The fly-back pulse occurring at this point is usually of sufficient amplitude to serve for blanking purposes and is readily accessible. The pulse is taken via a capacitor to the tube grid, and to prevent it being short circuited by the grid decoupling capacitor a 100kΩ resistor is

added in series with the grid lead. A further R-C combination is included to shape the pulse by removing the sharp leading edge. Should the circuit be found to have the opposite effect to that required, that is to brighten the flyback lines, reverse the leads marked X-X. In receivers in which the tube grid is modulated, the same arrangement is employed except that the blanking pulse is fed to the cathode.

Mains Unit for FM Tuners *(continued from page 403)*

Dealing next with those remaining pin connections of the 6X4 valve, from pins 3 and 4, to which we have already made some connections, solder to each a length of wire sufficient to reach the far side of the octal valveholder. Twist these together and solder the remaining ends to pins 2 and 7 of the octal holder; again, it does not matter which wire is soldered to either of the latter pins. These then become the h.t. output sockets of the power unit. To pin 7 of the 6X4 holder, solder one end of a length of wire, the other end of this being connected to the red solder tag of the condenser. This completes the wiring of the rectifier valve.

Across the two condenser tags solder into position the resistor R₁, and to the plain tag of the condenser solder a length of wire, the

other end of which is soldered to pin 5 of the octal holder. This latter connection then becomes the h.t.+ output socket of the power unit. The last connection is that from pin 8 of the octal holder to the earthed tag fitted under the condenser securing nut. This latter connection now becomes the h.t.—output socket of the power unit. With a suitable power point plug fitted to the mains lead, and the valve inserted into position, the unit is now ready for use with that item of equipment requiring a power supply.

A connector may be made, as mentioned previously, from an old octal valve base into which the required connecting wires are soldered, or a proper octal connector may be purchased at the local radio stores.

The Satellite Pre-Tuned FM Unit *(continued from page 413)*

The power requirements of the unit are fairly modest, and may in some cases be available from the power supply already fitted to the amplifier. The heater power required is 6.3 volts at 1.8 amps. The h.t. current consumed by the unit is of the order of 37mA; and the h.t. voltage should lie between 200 and 250.

The particular type of a.f. amplifier employed will depend mainly upon the requirements of the constructor. However, so far as amplification itself is concerned, it is probable that a gain of the order of that given by a triode voltage amplifier followed by a pentode output valve will be more than adequate.

Radio Miscellany *(continued from page 405)*

J.M. writes that I spoke of G2BZ—not 2BZ. Sorry, my mistake. Of course, there were no G's in those days. Whoever heard of G2LO?

* * *

J.C. of Bromley, Kent, adds to the list of forgotten names and asks if anyone has heard of John Scott-Taggart in recent years?

* * *

Finally, a circular letter and a cartoon from ex-DL1CU which makes my poor dazed head spin. I gather that he has risen to defend the amateur 7 Mc/s band against interlopers. I tried to do that once myself, and many others

have protested without effect. However, as he seems to have circulated leaflets inciting others to interfere with the "offenders," the German P.O. revoked his licence.

I wish I could completely understand the quaintly worded letter—I am fully in sympathy with defending what little remains of the radio spectrum for amateur use. But the means! It must have been a pretty hot attack for Diplomatic steps and Foreign Ministries to have taken it up. Does anybody understand the details? I am afraid that even with my full vigour restored and a clear head I shall still not be able to sort out the Good Indians and the Dead Indians he writes about.

A Switch-Tuned Superhet

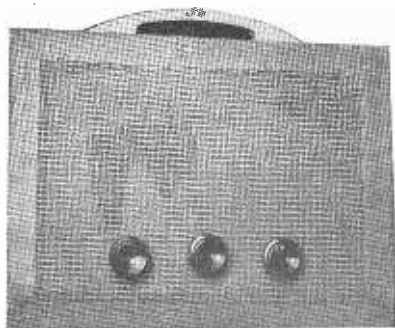

by P. R. TRAVERS

ALTHOUGH THE B.B.C.'S NEW FREQUENCY modulated v.h.f. service has inspired the design of many tuners, some of which are switch-tuned, there are still those who, by reason of economy or because they are outside the service area of their nearest v.h.f. transmitter, have use for a medium wave broadcast receiver. The writer was recently asked to build a medium wave receiver with a fairly stiff specification:

- (1) It was to be built with ex-Government components to keep the price to a minimum.
- (2) It was to be switch-tuned, and capable of being pre-tuned to any three stations in the medium waveband. This condition implied reasonable selectivity so that Continental stations could be preset if required.
- (3) It should be transportable.
- (4) The quality of reproduction was to be high enough to allow musical programmes to be listened to by a keen musician.

The problems of design were thus divided into two groups, those associated with the tuning system and those of providing reasonably high quality audio amplification.

Tuning Arrangements

Whilst there are several methods of providing switch tuning, probably the cheapest method is to switch pre-set capacitors across the tuning inductance. The alternative method of switching pre-tuned coils is probably better, but is much more costly. Switched capacitors were used in this instance, and by mounting them on a perspex shelf

next to the switch no problems of instability were encountered. The inductance used was an Osmor QA5, which gives excellent selectivity. 500pF trimmers were used, and these allowed tuning over the medium wave band from 200 metres to a little over 470 metres. It is possible that 350pF trimmers might have to be used in some instances to tune the end of the band, if the layout of the trimmers was different from that used by the writer. The frequency changer was a 6K8, which is freely available on the surplus market. A tuned grid oscillator was used, based on the Osmor QO8 oscillator coil. Once again switched capacitors are employed across the coil and this arrangement has proved to be perfectly satisfactory. The h.t. to the oscillator anode via the coil is supplied from the main h.t. rail through a 47kΩ 1W resistor. A.V.C. is parallel fed to the frequency changer grid through a 1MΩ resistor.

I.F. Stage and Detector

The i.f. stage is entirely conventional and uses a 6K7. Some economy is effected by supplying the screen grids of both the frequency changer and the i.f. valve from a potentiometer across the h.t. supply, the lower arm of which is decoupled by a 0.01μF capacitor. The i.f. stage is controlled by the a.v.c. in the usual manner. By using pre-aligned i.f. transformers no problems were encountered when lining up the set on completion.

The detector is a 6Q7, separate diodes being used for signal detection and for a.v.c., the latter being derived from the anode of the i.f. valve via a 50pF capacitor.

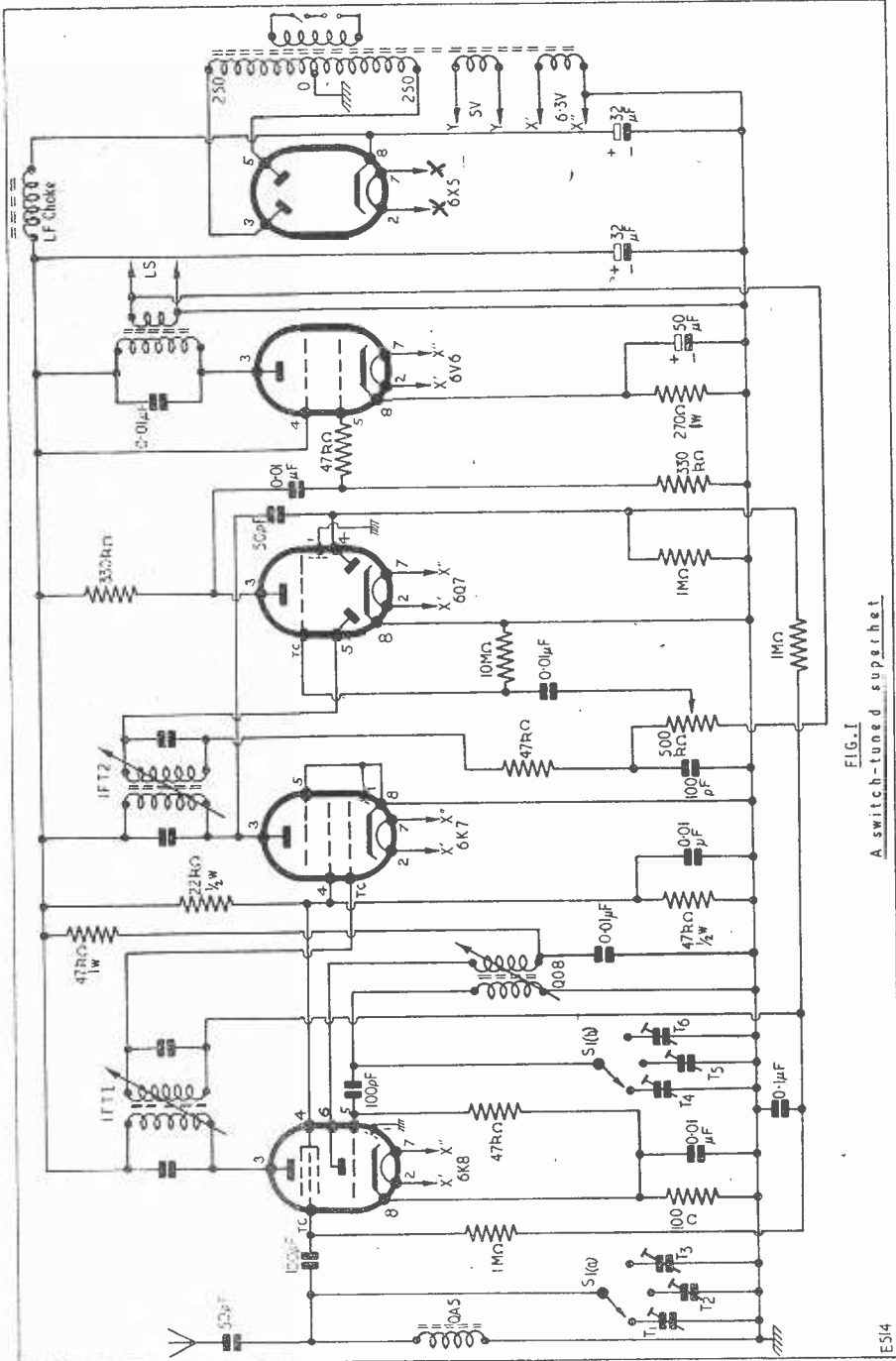

FIG. 1
A switch-tuned superhet.

Audio Stages

The triode section of the 6Q7 provides the first stage of audio amplification, the signal being tapped off the volume control; and this is followed by the output stage which uses a 6V6. If a fairly high quality result is sought, then some degree of negative feedback is needed. The simplest way to achieve this is to omit the capacitor in the cathode circuit of the output valve, but the amount of feedback is really too small to be of much use. The next easiest way is to connect a resistor between the anodes of the output and 6Q7 valves, the amount of feedback being adjusted by varying the value of the resistor. This again is not a very satisfactory method, as the feedback is only over the output valve, the output transformer and triode amplifier being outside the feedback loop. The output transformer is included if the cathode bias resistor of the output valve is taken to the non-earthed side of the output transformer secondary. There is, however, one method of supplying negative feedback* which embraces all the audio stages, and has the further advantage that it is variable so that on strong signals it is at a maximum and musical programmes from local transmitters can be listened to with maximum fidelity, whilst weak Continental transmissions can be heard well using the maximum audio gain if required. The feedback is obtained by returning the bottom of the gain control to one side of the output transformer secondary, the opposite side being earthed. When the gain control is turned well down, feedback is at a maximum and distortion is accordingly decreased; as the gain is turned up, feedback is proportionately reduced and the full gain of the amplifier stages becomes available. For completely smooth operation a linear potentiometer is to be preferred for the gain control, but a log law component gives very satisfactory results. The 0.01 μ F capacitor across the output transformer primary provides a certain amount of top cut.

* S. W. Amos, *Wireless World* August 1956

Power Pack

A 250-0-250V transformer supplies the h.t., and as the component available had a separate 5-volt winding a 6X5 was used as the rectifier. A small l.f. choke is used for smoothing, and the amount of hum is negligible.

Cabinet

As the receiver had to be transportable, the cabinet was "tailor made" to fit the chassis, the dimensions of which were 14in \times 6in \times 2 $\frac{1}{2}$ in. A 6in speaker is used, and the chassis is arranged at a slight angle both to ease the operation of the controls when the set is standing on a table and also to improve the diffusion of sound.

The pre-set capacitors are readily available for adjustment if the set is turned on its back. After several weeks use, in which the receiver has been deliberately ill-treated and knocked about, no drift in the tuning has been noticed.

Alignment presents no problems. The core of each coil is adjusted until the Home Service is received with one set of capacitors at about their mid-positions; slight adjustments can then be made to the i.f. transformers if necessary. The other stations that are required are then tuned by adjustment of the oscillator and then the aerial trimmers.

The aerial consists of about 8ft of wire wound round inside the back of the cabinet, and this has proved quite adequate for reception of the three B.B.C. programmes, Radio Luxembourg, Hilversum and other Continental stations in the north-west London area.

This receiver has proved to fulfil all the requirements of its design. No attempt at miniaturisation was made as the chassis used was already to hand, and standard components were used to meet the requirement of low cost. The quality of the reception is of a remarkably high standard, and would, no doubt, be improved still further if a high-class output transformer, a better speaker and a larger cabinet were to be used.

1958 Electrical Engineers' Exhibition

The Rt. Hon. Sir David Eccles, K.C.V.O., M.P., President of the Board of Trade, will open Britain's largest-ever display of Electrical Equipment at The Electrical Engineers' Exhibition to be held at Earls Court from 25th to 29th March, 1958.

This Exhibition now ranks as one of the largest in the country, and the demand for space has necessitated further expansion on the first floor, all of which will be in use for next year's exhibition. So far nearly 400 firms have booked space, and the Exhibition will cover an area of 450,000 square feet.

Several exhibitors are taking advantage of this expansion by booking additional space on the first floor, where they will show domestic equipment and lighting

fittings, etc., retaining the ground floor stand for their heavier industrial gear.

Special features are being planned to attract visitors to the first floor: a display of Electricity in Hospitals will be the principal feature, but the stands covering Education in the Electrical Field, Careers and Training, Training in the Services, Institutions and Associations should all make the first floor very attractive.

To facilitate access to the first floor exhibits a staircase is being built which in itself will be a striking feature of the Exhibition.

Further information: Mr. Peter Collins, 79 Leghorn Road, N.W.10. Telephone ELGar 6761.

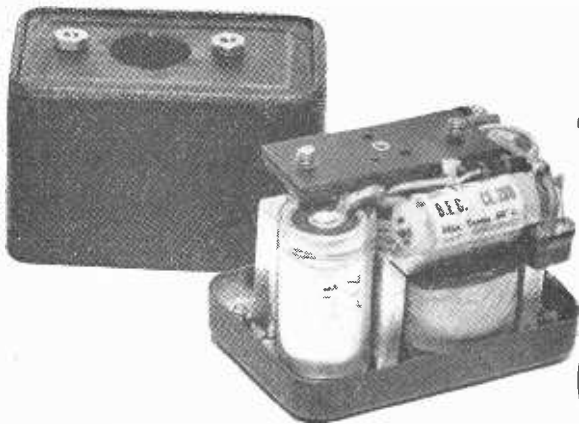

A TRANSISTOR D.C. CONVERTER

by D. S. WATSON, D.F.H., Grad.I.E.E.

DUE TO THE COST AND COMPARATIVELY short life of layer type h.t. batteries, the writer recently developed a small d.c. converter to provide the h.t. for a radio controlled boat. The complete unit measures only $2\frac{1}{2}$ in \times $1\frac{1}{2}$ in \times $1\frac{1}{2}$ in and weighs 6oz, and it is capable of providing a continuous output of over 70 volts at 5 mA when fed from a 6-volt supply. The following details of the unit may be of interest to readers, but before dealing with the constructional features let us briefly consider the principles of operation.

Operation

A steady d.c. voltage cannot be directly stepped up in value as in the case of an alternating voltage. In order to achieve this, it is necessary first of all to convert the d.c. into an alternating voltage (or interrupted d.c. voltage), secondly to transform this to a higher a.c. voltage, and finally to rectify this a.c. voltage back to d.c. This may seem a long way round, but with the advent of transistors this can be achieved comparatively simply and with the use of few components.

Fig. 1 shows the basic circuit of a transistor d.c. converter where:

- P is the primary winding
- F is the feedback winding
- S is the secondary winding.

The transistor, primary and feedback windings form a straightforward a.f. oscillator, the frequency of which depends on the circuit constants. Under oscillating conditions an alternating voltage is generated in the

secondary winding of the transformer. The magnitude of this voltage is dependent largely on the ratio of the primary to secondary turns. This voltage is rectified by the diode, D. The capacitor, C, acts as a reservoir and smoothing capacitor to provide a steady d.c. potential to the load, R_L . In practice the magnitude of the output voltage depends not only upon the transformer ratio, but also upon the input voltage and the transformer/frequency/load characteristic.

It will be appreciated that the output obtainable from an oscillator of this nature is determined largely by the dissipation rating of the transistor, and for optimum performance the circuit losses must be kept to a minimum. From practical considerations, however, one is limited in the choice of components by materials that are readily obtainable, especially so far as the transformer laminations and transistors are concerned. In view of this the final circuit takes the form shown in Fig. 2, which it will be seen consists of two oscillator circuits with their outputs electrically connected in series. This is necessary to provide the h.t. power required by the receiver under maximum current conditions. The heaviest components are the transformers, and it is doubtful if any disadvantage is incurred by the use of two transformers as each one only carries half the power that would be carried by a single transformer. Admittedly, the cost is increased by the necessity of two rectifying circuits; but for the output required a push-pull oscillator

circuit is indicated, necessitating the use of the two transistors, and these contribute to the larger part of the total cost of the unit.

Construction

The most critical components in the circuit are the transformers. These are hand-wound and are based on miniature 3S4 output transformers with suitably modified windings. The transformers in question incorporate "T" and "U" laminations of the dimensions shown in Fig. 3 and stacked $\frac{1}{2}$ in deep. The transformers should be carefully dismantled by removing the laminations and unwinding the secondary. The primary and its associated insulated tape covering should be left in position on the bobbin as this winding is

the ends several times through holes in the bobbin cheeks and leaving several inches for connections, a layer of insulation should be applied. This may consist of a strip of waxed paper cut to the appropriate width and length to completely cover the windings. The feedback winding is then added. This consists of 60 turns of 36 s.w.g. enamelled wire. The windings are then complete and should be covered with a final layer of insulation. It will be of assistance when ultimately wiring up the unit for testing if both the windings are wound in the same direction, and a note kept of the location of the start and finish of both windings.

Having completed the windings and secured the outer layer of insulation, the laminations should be replaced, arranged with

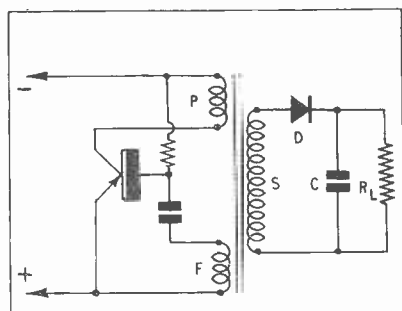

FIG. 1.
BASIC CIRCUIT OF THE CONVERTER

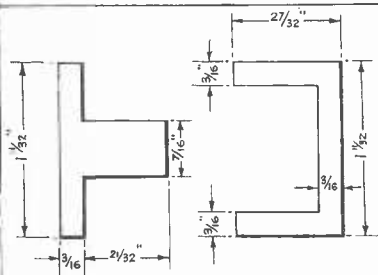

FIG. 3.
DIMENSIONS OF TRANSFORMER LAMINATIONS

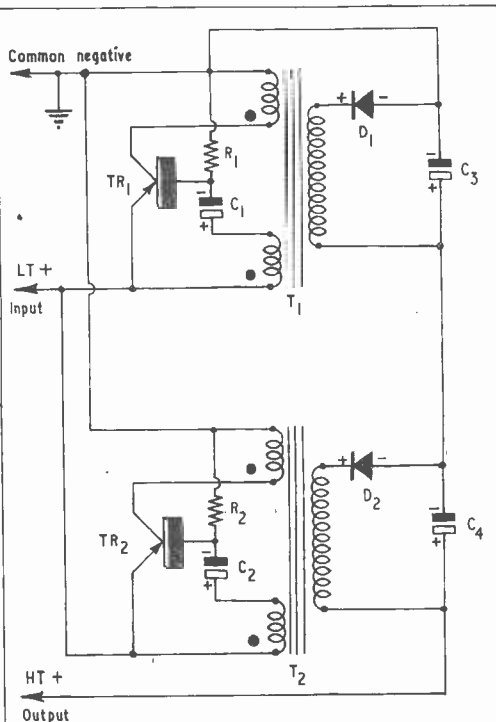

FIG. 2.
FINAL CIRCUIT OF THE CONVERTER

G443

ultimately used as the output or secondary winding of the converter. The next step is to wind on 350 turns of 36 s.w.g. enamelled wire as evenly as possible. This will be used as the primary winding of the oscillator. Having securely anchored the wire by threading

alternate "T" and "U" laminations so that the junction of each pair of laminations alternate from one end of the bobbin to the other (in its original state as an output transformer, the laminations will have been assembled to form a butt joint).

circuit is indicated, necessitating the use of two transistors, and these contribute to the larger part of the total cost of the unit.

Construction

The most critical components in the circuit are the transformers. These are hand-wound and are based on miniature 3S4 output transformers with suitably modified windings. The transformers in question incorporate "T" and "U" laminations of the dimensions shown in Fig. 3 and stacked $\frac{1}{4}$ in deep. The transformers should be carefully dismantled by removing the laminations and unwinding the secondary. The primary and its associated insulated tape covering should be left in position on the bobbin as this winding is

the ends several times through holes in the bobbin cheeks and leaving several inches for connections, a layer of insulation should be applied. This may consist of a strip of waxed paper cut to the appropriate width and length to completely cover the windings. The feedback winding is then added. This consists of 60 turns of 36 s.w.g. enamelled wire. The windings are then complete and should be covered with a final layer of insulation. It will be of assistance when ultimately wiring up the unit for testing if both the windings are wound in the same direction, and a note kept of the location of the start and finish of both windings.

Having completed the windings and secured the outer layer of insulation, the laminations should be replaced, arranged with

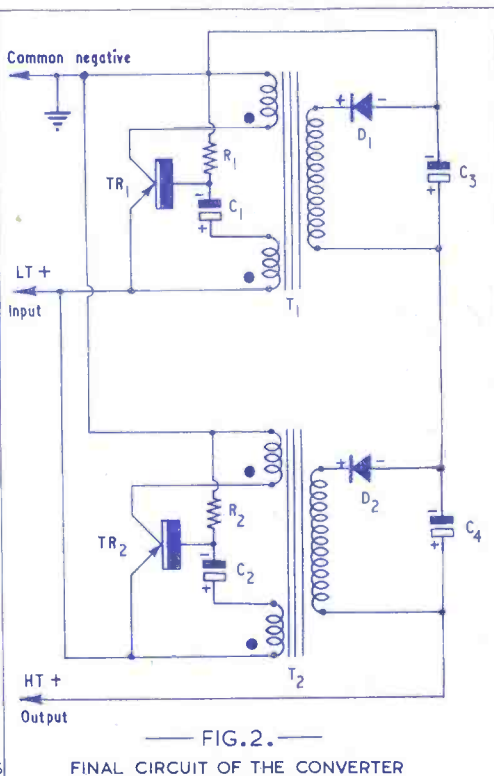
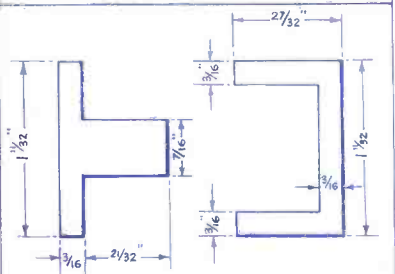
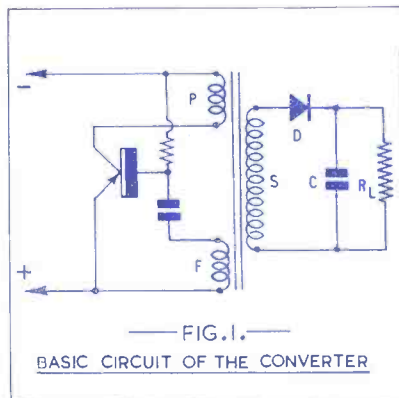

ultimately used as the output or secondary winding of the converter. The next step is to wind on 350 turns of 36 s.w.g. enamelled wire as evenly as possible. This will be used as the primary winding of the oscillator. Having securely anchored the wire by threading

alternate "T" and "U" laminations so that the junction of each pair of laminations alternate from one end of the bobbin to the other (in its original state as an output transformer, the laminations will have been assembled to form a butt joint).

When the transformers have been reassembled, the components should be wired up for independent testing of the two oscillator circuits. At this stage the secondary windings should be left disconnected. Care must be exercised when wiring up to avoid fracturing the transformer leads or damaging the transistors by overheating during soldering. The primary and feedback winding terminations marked with a dot on the circuit diagram are the corresponding ends of the windings assuming that they have been wound in the same direction, i.e. either both the start ends of the windings or both the finish ends.

an a.f. note, the circuit may be oscillating satisfactorily but outside the audible range, in which case the transformer characteristics are incorrect. To check this, connect up the output circuit of the faulty oscillator and see if a d.c. voltage reading is obtainable. If so, the circuit is basically in order, but the transformer should be checked for possible faults. A faulty transformer is also indicated if no meter reading can be obtained, assuming that the foregoing points have been checked. The circuit should give little trouble, however, and should oscillate readily and with a reasonable degree of stability. The frequency

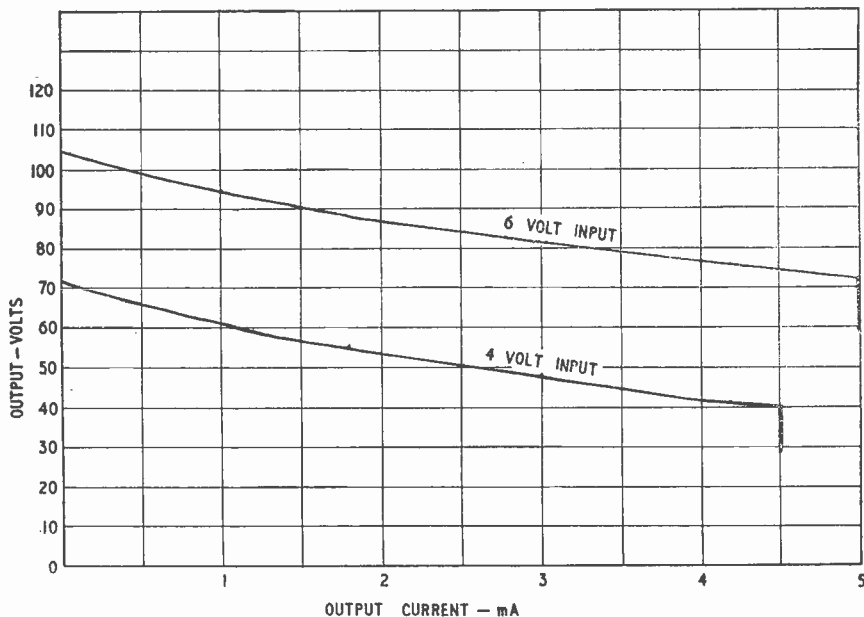

FIG. 4. REGULATION CURVES OF CONVERTER

G444

Testing and Fault Finding

To check for oscillation, the speech coil of a loudspeaker should be temporarily connected across each feedback winding in turn, when a high-pitched note should be heard. If no a.f. note is audible the connections to either the primary or feedback windings should be reversed. Assuming that the transformer has been wound in accordance with the details given above, the oscillator circuits should work satisfactorily; if not, one of the components may be faulty or the trouble may lie in the wiring. Make sure that the output (secondary) windings are not accidentally shorting. If it is still not possible to obtain

of oscillation can be varied by altering the time constant of the R-C circuit; it will be increased by reducing the transformer core area or by reducing the battery input voltage, and vice-versa. The circuit conditions, however, should not be radically changed from those shown. The gauge of wire used for the transformer winding is also important, and any considerable increase of winding resistance may lead to trouble.

When the circuits oscillate satisfactorily, the loudspeaker should be disconnected and the two rectifying circuits wired up but not commoned at this stage. It should be noted that the output from the oscillators tends to

be in the nature of uni-directional pulses, and it will be found that by reversing the rectifying diode (and electrolytic capacitor polarity), a greater d.c. voltage is obtained in one direction than the other. The connection giving the greatest output should, of course, be selected. Having ascertained the correct output connections, the two rectifying circuits are connected in series and the voltage checked to ensure that all is well. A reading of the order of 70 volts should be obtained with an input of $4\text{-}4\frac{1}{2}$ volts, on open circuit; alternatively, approximately 100 volts

at around $4\frac{1}{2}$ to 5 mA. In consequence it is important when the unit is to be used to provide h.t. to a radio control receiver, for example, that the receiver is adjusted so that under maximum current conditions the current demand does not exceed, say, 4mA assuming h.t. cut-off at $4\frac{1}{2}$ mA.

Having satisfactorily completed the testing, the converter components should be disconnected and the transformers dried out in a warm oven and immersed in shellac varnish or insulating wax and allowed to harden thoroughly. The mounting clips are fitted at

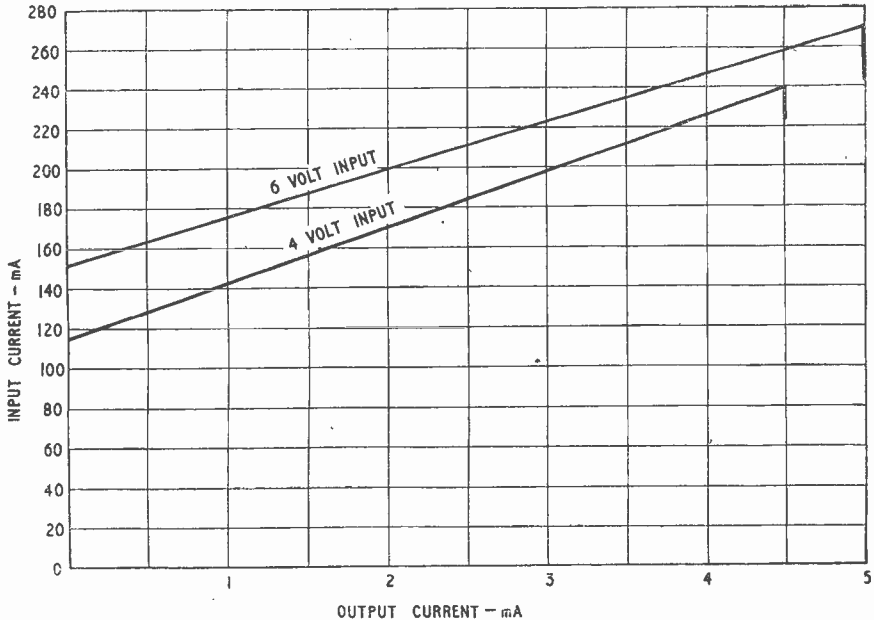

FIG.5. GRAPH SHOWING RELATION OF INPUT CURRENT TO OUTPUT CURRENT OF CONVERTER UNDER WORKING CONDITIONS

G 445

with an input of 6 volts. The transformer connections should be noted to ensure correct reconnection when undertaking the final assembly of the unit.

The next step is to draw up a regulation curve of the unit. A variable resistor is connected across the output of the unit in series with a milliammeter, and the resistor shunted by a voltmeter. A series of output voltage against current readings can be taken for varying values of load resistance. A regulation curve should then be plotted and should resemble that of the original unit, which is shown in Fig. 4.

It will be noted that the converter "cuts off"

this stage and the final assembly of the unit undertaken.

The unit shown in the photograph was mounted on the inside of a Colman's mustard tin lid, the tin itself being cut down to $1\frac{1}{2}$ in and used as a cover. External connections to the unit are made via a small three-pin socket.

Peak efficiency of the unit is obtained near full load, when it is of the order of 22% with a 6-volt input.

It should be noted that the rating of transistors is determined by the final temperature attained by the germanium element under working conditions, and in consequence

their rating decreases with ambient temperature. Care should be taken, therefore, to ensure that the transistors are mounted well clear of heat generating components, especially where the unit is to be built into another piece of equipment.

Germanium diodes were used in the original unit for providing half-wave rectification of the oscillator output voltages in view of the considerable space saving afforded by this type of rectifier, bearing in mind the low forward resistance and high reverse resistance, giving greater overall efficiency when compared to other types of rectifiers at present available. The rectifiers should have a mean forward current rating of 5 mA minimum and a minimum peak inverse voltage rating of 80 volts.

So far the unit has given many hours of satisfactory operation with no apparent deterioration, and soon pays for itself by virtue of the saving in h.t. battery costs.

Components List

TR1, TR2	Junction transistors (Mullard OC71 or equivalent)
T1, T2	Oscillator transformers, see text
R1, R2	200 ohm $\frac{1}{4}$ watt resistors
C1, C2	25 μ F, 25 volt electrolytic capacitors
C3, C4	8 μ F, 150 volt electrolytic capacitors
D1, D2	Germanium diodes, see text
	Miniature three-pin socket
	Case (see text), nuts, screws, connecting wire, etc.

Can Anyone Help?

Requests for information are inserted in this section free of charge; subject to space being available

P. JACKSON, 79 Stratfield Road, Oakridge, Basingstoke, Hants., would like to contact any reader who has successfully substituted modern miniature valves for the r.f. stages in the Marconi CR.100 receiver.

P. J. DARKE, 5 Whalley Lane, Uplyme, Lyme Regis, Dorset, wishes to buy, borrow or hire any information on the U.S. Govt. BC.64.A, CCT.52210, CCT.4612, CCT.5204 and CBY.46129.

V. REES, 29 Bartlett Street, Caerphilly, Glam., has a "Defiant" TR479 receiver which has developed an obscure fault in the line timebase. Any information, service data, etc., which would prove helpful would be gratefully received on loan; or is willing to purchase.

A. H. SARTAIN, 10 Ash Grove, Palmers Green, London, N.13, is in need of circuit diagrams, service data, or any information on "Romac" television receivers. Can anyone help?

M. J. BARRINGTON, The Ferns, Coniston Road, New Thundersley, Essex, would like to borrow or purchase the circuit and any data on the Philips receiver type 701AX, and would also like to hear from anyone who has the valves TV4 and A27D for disposal.

F. W. CHATTAWAY, 105 Clovelly Road, Wyken, Coventry, requires, and will be pleased to pay for, circuits, details, etc., of the A.M. type R.3170A receiver.

B. H. WYNN, "Black Cat," Abbess Roding, Ongar, Essex, appeals for information and the loan of the service manual for the Fleet Air Arm battery receiver R.1116A. He is willing to pay for the loan and guarantees safe return.

N. PRETTY, Buckingham House, High Street, Great Missenden, Bucks., needs the circuit or instruction manual on the Canadian receiver type R.103, Mark I, D.E.I.L. He will be pleased to purchase same, or would appreciate the loan thereof for a short period, paying all expenses.

B. J. ARMITAGE, 39 Bradford Road, Birstall, near Leeds, Yorks., asks if any reader has for sale or hire the circuit diagram and the frequency coverage of the Bendix Aircraft receiver model RA.10.FB.

D. B. JONES, 36 Sycamore Grove, Southend-on-Sea, Essex, wishes to buy or borrow a manual or handbook on the CR.100/2.

F. G. BIRTWISTLE, 25 Findlay Street, Belfast, N. Ireland, has a Pye 5-valve universal receiver. 3-wavebands, marked with Indian and Near East station names such as Bombay, Lahore, Durban, etc., and the shortwave bands are marked with African and American stations. There are 4 valves, with one missing. The first three are ECH35, EF39 and EBC33. The rectifier is marked, apparently, 1BY-1004. Output valve is unknown. Can any reader supply any information, please?

P. A. GOWER, 23 Bincote Road, Enfield, Middlesex, tel. ENF3961, has built the Windsor television and wishes to compare results with anyone in or near Enfield.

683700 A/A HAMMAN, Hut 373, "B" Sqdn., 1 Wing, R.A.F. Locking, Weston-super-Mare, Somerset, needs information on converting the No. 19 Set Mk. II to mains operation, and also details of the 6- and 12-pin connections.

C. F. BEAL, "Charres," Huggetts Lane, Willington, Eastbourne, Sussex, would like to obtain a service sheet for the Ferguson 988T television.

S. E. WRIGHT, 88 Blackman Avenue, St. Leonards-on-Sea, Sussex, is in need of the circuit diagram (values and wiring only) of the BC.348.Q (this is not the same as the BC.348.0). He particularly needs the wiring of the r.f. anode circuits and the crystal filter.

R. E. JONES, School House, The College, Bishop's Stortford, Herts., requires service data for the 38 Transreceiver. Can anyone help?

J. G. SUMMERHILL, "Dorsley," 36 Eldorado Road, Cheltenham, Glos., asks if anyone can lend or sell data and circuits of the RF24 unit and its conversion, and also the same for the R.1125.

N. MILLER, 29 Chadacre Road, Stoneleigh, Surrey, requires circuit diagram and technical information on the Oscillator unit 204 Stores ref. 10V/16001, and the Sender Mk. 36 Cat. No. ZA3234BD, Serial No. 95.

Magnetic Tape Recorders

MICROPHONES—*The Weakest Link?*

PART I

By A. BARTLETT STILL

IN A PREVIOUS SERIES OF ARTICLES UNDER the general heading "Magnetic Tape Recorders," an attempt was made to assist home constructors who wished to make a tape recorder having a performance comparable with the better commercially made models, utilising the best available tape decks. Such a machine, fulfilling the imposed specification, might well be considered to come within the much used (and much abused) term high fidelity.

It must be admitted that, whatever limitations be imposed by the copyright acts, such machines are used in the main for recording from the radio, or for dubbing gramophone records. With the advent of V.H.F./F.M. broadcasting there is no doubt that a source of programme material of extremely high quality is available to the majority of tape recorder owners. This has the disadvantage, or perhaps advantage, of providing a yard stick against which all other recordings tend to be judged.

It is a fact, however, that while radio recording may perhaps be the most common use of tape recorders, the making of one's own recordings in the home provides the most exciting use of the medium. The possibilities are numberless. Quite apart from the fun that may be had at a party, the teacher can rehearse his lecture, or the musician can turn his critical ear to the playback of his own rehearsals. These uses of a tape recorder, and the thousand others, all have one thing in common. They are live recordings and require the use of a microphone, together with a certain knowledge of microphone technique. It is, however, unfortunately true that the performance of the microphone used rarely comes up to the performance of a tape recorder such as we are considering, with the result that recordings never approach the quality obtained in other directions. The microphone has, therefore, come to be con-

sidered as the weak link in the chain, a phrase that was in fact used in a reader's letter which prompted this article.

It is, therefore, proposed to examine the whole question of microphones and their use, to see whether the weak link cannot be strengthened. To do this, we must first determine exactly what our microphone is required to do. It is a device which will pick up acoustic energy from the surrounding air, and transform it as faithfully as possible into electrical energy, such as may be amplified and recorded satisfactorily. It is natural to seek the most efficient type of microphone, and it is therefore advantageous to determine exactly what is meant by efficiency in such an instrument. One microphone may be said to be more efficient than another if it provides a greater electrical signal for a given sound; alternatively, efficiency may be reckoned in terms of fidelity. It is unfortunately true that any one type of microphone is rarely efficient in both these respects; in other words, one cannot have both quantity and quality.

Probably the most efficient microphone available at the present time in terms of magnitude of output is the carbon granule type used in the ordinary telephone. The performance of such a microphone, however, in terms of frequency response and distortion is such as to render it virtually useless in any form of high fidelity recording work. Piezo-electric or crystal microphones are available at the present day in considerable quantities, and the price ranges from a matter of a pound or two upwards. In general they are reasonably sensitive, and some of the more expensive types are capable of reasonable faithfulness in reproduction. Though there are certain disadvantages in the use of this type of microphone, it will be worth our while to examine it in greater detail later on. The condenser microphone has never become

really popular, though one particular type is readily available at the present time, and may be said to have much to commend it. The dynamic, or moving coil, microphone, similar in construction to a small loud-speaker, will often provide a useful compromise between performance in respect of frequency response and the sensitivity that is so often required. It has, however, long been agreed that the ultimate performance in terms of frequency response and fidelity can only be obtained through the use of a ribbon microphone. This type of microphone, unfortunately, is in general rather less sensitive than the other types, but is worthy of inclusion in our review.

During the London Audio Fair, held earlier this year, an opportunity was taken of collecting information in respect of the various models of microphone offered by the different manufacturers. All the four types mentioned earlier were represented, although only one example of each of the condenser, and crystal microphones were seen by the writer. There seems, however, to be no lack of variety in respect of moving coil and ribbon microphones.

It was noticed that, from more than one manufacturer, a certain model of microphone is available in three different impedance types. The usual lower impedance matching is for 25 or 30 ohms, one alternative is the usual line impedance of 600 ohms, and latterly microphones are provided in hi-Z versions designed to do away with an input transformer in the pre-amplifier unit. These types are usually known as high impedance versions, although the actual matching impedance is only of the order of 50,000 ohms. The uninitiated may be somewhat confused, however, in that with such an arrangement three different figures have to be quoted for the sensitivity of what is, after all, basically the one microphone. In consequence a word or two of explanation as to the normal method of indicating the sensitivity of a microphone might not be out of place.

As mentioned earlier, sensitivity of a microphone is reckoned in terms of the magnitude of electrical signal delivered for a given acoustic signal. This in a practical sense is usually taken to be a sine wave signal of 1,000 cycles per second, the acoustic level being one dyne/cm². The sensitivity of a given microphone may therefore be quoted as X mV per dyne/cm², though it is more usual to refer to the sensitivity figure as being a certain number of decibels down upon one volt per dyne/cm². This may be even further complicated by virtue of the fact that the "dyne/cm²" portion may be omitted and the sensitivity given simply as X db.

The lay mind may at once be confused by the term "dyne/cm²." It is a way of express-

ing atmospheric pressure, and sometimes the term "microbar" (μ bar) is used. Readers may call to mind the term "Millibar" used in weather forecasting charts. In order to bridge the gulf between weather forecasting and microphone recording for the home enthusiast, some "rule of thumb" is obviously required, and fortunately one exists. The average man's conversational voice, speaking at a distance of three feet, exerts a pressure on the microphone of approximately one dyne/cm². Taking, as an example, a hi-Z moving coil microphone with a published sensitivity of -54 db, one would expect, under those conditions, to obtain an output of 2 millivolts r.m.s. during the peaks of sound.

Let us leave the question of the "quantity" of electrical output for a moment, and look at the other variable, "quality." Although the two terms distortion and frequency response will both spring to the mind of the high fidelity enthusiast, it is unlikely that the microphones we are considering will give rise to measurable distortion under normal conditions of use. Unfortunately, while many manufacturers will cheerfully claim the frequency response of their product to be "x c/s to y kc/s," few of them are prepared to give the equally important " \pm Zdb." Leaving aside the really expensive "professional" equipment, it is the writer's experience that, over the range specified, the general curve will lie within \pm 5db, with occasional peaks or troughs extending to 10db.

Such limits, though at first sight poor when compared to the usual specification of a good quality amplifier or tape recorder, prove in practice to be adequate. This is due to the marked effect of "room acoustics" on the apparent performance on the one hand, and also to the fact that certain conditions of use require not a wide, but a restricted response in order to achieve the cleanest recording. But more of that later; for the moment, let us examine the various types available in turn to decide upon their relative advantages or otherwise.

Crystal Types

Crystal microphones are available at prices from a couple of pounds upwards. They are normally of high impedance, though occasionally they can be obtained with a built-in step-down transformer, and consequently are suitable for direct connection to the grid circuit of a valve.

Sensitivity is generally of the order of -55db, and so they should be suitable for a tape recorder requiring an input of 2mV or thereabouts.

The frequency response of the cheaper crystal microphones is not wide, and can in fact be something of a variable quantity. The

usual range quoted is about 50-6,000 c/s, but it must be stressed that the low frequency performance is dependent upon the input load. The microphone insert is capacitive, about 1,500 to 2,000pF, and this capacity, being in series with the output voltage, forms a bass cut filter with the input load. This load has, in consequence, to be about 5 megohms if the response is to be maintained down to 50 c/s. This will call for careful attention to the design and screening of the microphone pre-amplifier.

be allowed to equal the microphone capacity, the output will drop by 6db. As indicated in respect to the pre-amplifier, the screening of the cable will have to be very good if hum is to be avoided. As a practical note, it must be said that normal 75 ohm co-axial cable will not be good enough.

Condenser Types

Much that has been said about crystal microphones applies equally to condenser types. The frequency response and sensitivity

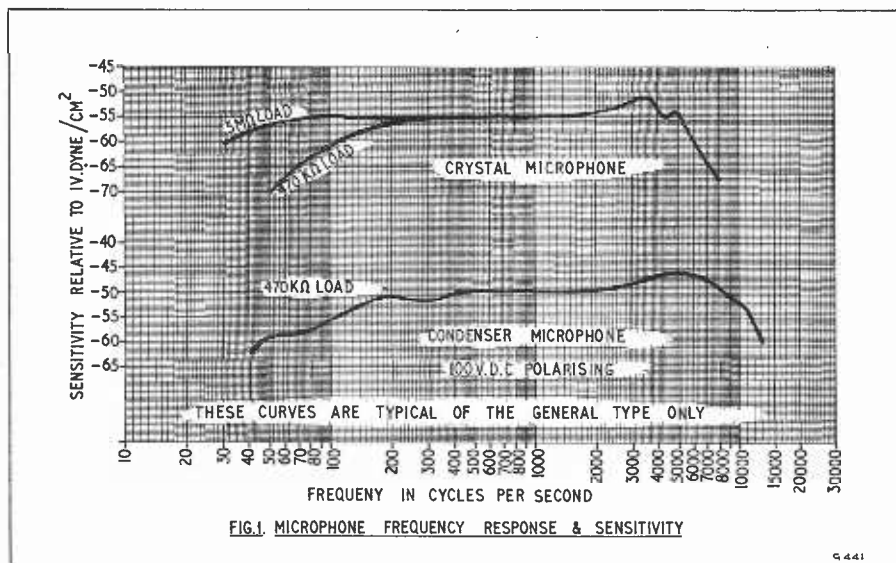

This unique feature of crystal microphones can often be turned to advantage. It is well known that for speech recording only, a good low frequency response is sometimes a disadvantage. A crystal unit, working into a load of 470kΩ or 1MΩ, will give very "clean" results on speech, with an absence of "building rumble."

By virtue of the capacitive nature of the source, and the high input loading required, particular care has to be taken when wishing to extend the microphone cable. The self capacity of the cable, if allowed to become an appreciable quantity when compared to the microphone capacity, tends to reduce the output in addition to any slight effect it may have on the frequency response. Should it

are generally better, but a good microphone built on this principle is definitely more expensive, and usually out of reach of the pocket of the home constructor. It also suffers from the added disadvantage that a d.c. polarising voltage is required. This not only tends to complicate the pre-amplifier circuitry, but also requires that the connecting cable, in addition to the features shown above, must have a very high leakage resistance if unwanted noise is not to be introduced.

In next month's article we shall continue our more detailed examination, dealing with the popular moving coil and ribbon types, and then discuss the various factors that should determine our ultimate choice.

To be continued

A Sensitive Crystal Receiver

An efficient circuit with
self-adjusting bias supply

By R. WALLACE

THE COMING OF THE GERMANIUM DIODE HAS seen a great revival in the popularity of the crystal set. As well as being unaffected by knocks or vibrations, a receiver using one of these diodes does not need the delicate "cat's whisker" adjustment, which, although adding a certain excitement to listening somewhat lacking in these days of the push-button tuned superhet, was not altogether conducive to the relaxed enjoyment of programmes!

In areas reasonably near a transmitter, the type of circuit shown in Fig. 1 will probably be quite satisfactory, but where greater

must be adjusted to the optimum value. This is quite satisfactory when the set is to be operated only by someone who understands the procedure, but of course an entirely automatic arrangement has advantages, and as this can be achieved at a cost little or no greater than that of the ordinary type, it is well worth while.

Such a circuit is shown in Fig. 2, and it will be seen that two germanium diodes are used. One performs the function of a detector in the usual way and is taken to the appropriate connection on the coil, which is a Teletron type HAX. These coils have separate windings for aerial coupling and for correct matching to a crystal diode, which greatly improves selectivity. The other diode controls the bias voltage.

This second diode is shunted by a $10k\Omega$ and a $1k\Omega$ resistor in series, and if it were not present the voltage appearing across these due to the 1.5 volt cell and $20k\Omega$ resistor R_3 , would be approximately 0.5 volt. But the resistance of a germanium diode becomes progressively lower when any applied voltage rises above 0.25 volt or so; therefore, with a diode connected as shown in Fig. 2, the effect will be the same as putting a low resistance in parallel with R_1 and R_2 , and the voltage across these resistors will drop. When it reaches 0.25 volt, however, the resistance of the diode will rise again and the voltage across it will be held steady at this figure. This will hold good despite small variations in the applied voltage due to the d.c. component of the rectified signal or other causes.

In order that the voltage actually applied to the detector shall be just below the 0.25 volt required to bring it to the point where it starts to conduct, the voltage across R_1 only is used, which is slightly less than the total drop across R_1 and R_2 . The capacitor C_3 provides a low impedance path for a.f. voltages, and may be up to $12\mu F$ in value. If an electrolytic capacitor is used, care must be taken to observe the correct polarity. The

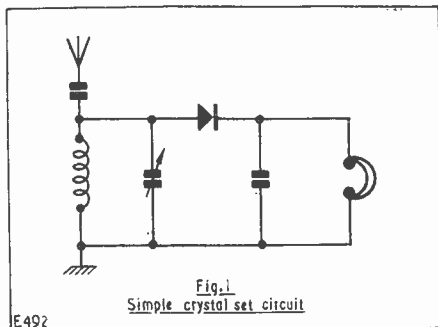

sensitivity or selectivity is required, something a little more ambitious is called for. Proper matching of the diode to the tuned circuit and the use of the correct type of headphones are important, and quite a considerable increase in output can be obtained by applying a small bias voltage to the diode to bring it to a point just below the conducting threshold; even the weakest signal will then be passed. The receiver described below will give improved results where signal strength is low and interference from other stations is troublesome.

The idea of applying bias is not new, of course, and the usual method is to use a potentiometer as a manual control, which

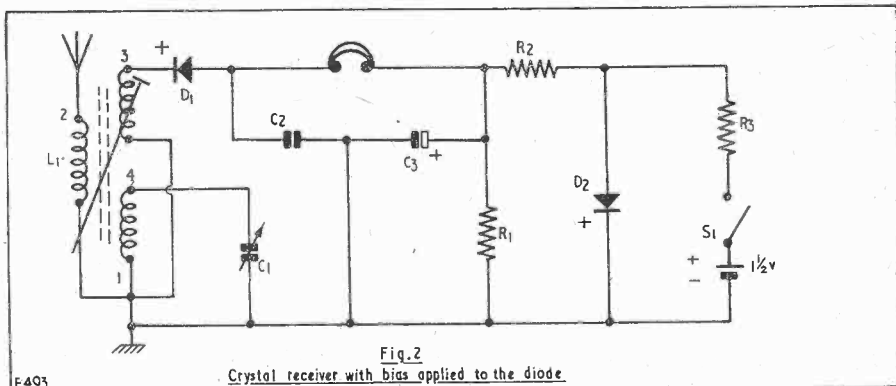

E493

phones used should preferably be of the low-resistance balanced-armature, or reed type.

The writer has used diodes purchased on the surplus market for D_1 and D_2 quite successfully, but if it is intended to use new diodes, the G.E.C. type GEX.34 is suitable for use in both positions. If greater efficiency is required, a GEX.45/1 is suggested for D_1 . When fitting the diodes care must be taken to see that they are connected the right way round. This is very important, and the connections shown in Fig. 2 *must* be adhered to.

also be connected the right way round, the zinc case being negative and the brass cap positive.

If it is desired to receive both Long and Medium waves, the coils may be mounted on old valve bases and plugged in as required; or alternatively a 4-pole 3-way switch could be used, with the third position controlling S_1 . In any case, S_1 should always be left open when the set is not in use to conserve the life of the dry cell.

Component List

Resistors

R_1 10k Ω $\frac{1}{4}$ watt

R_2 1k Ω $\frac{1}{4}$ watt

R_3 20k Ω $\frac{1}{4}$ watt

Capacitors

C_1 500pF variable condenser

C_2 0.001 μ F mica

C_3 12 μ F low voltage electrolytic

Inductances

L_1 (Medium waves) Teletron type HAX

L_1 (Long waves) Teletron type HAX-L

Diodes

D_1 GEX.34 or GEX.45/1

D_2 GEX.34

S_1 S.P.S.T. on/off switch

Phones Low-resistance balanced-armature

1.5 volt pen torch or hearing-aid cell

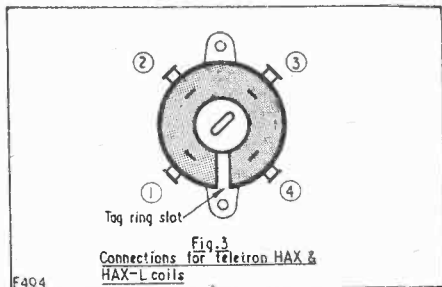

E494

In some diodes the end marked positive is coloured red, but in case of doubt this is the "cathode" or "crystal" end as opposed to the "cat's whisker" end. The 1.5 volt cell must

BOOKS AND CATALOGUES RECEIVED *continued from page 385*

A SIMPLE EXPLANATION OF SEMI-CONDUCTOR DEVICES issued by the Mullard Educational Service. Consisting of 22 pages, this most informative and colourfully produced booklet explains in simple and easy-to-understand terms both the manufacture and applications of these devices. Both the Germanium Diode and Transistors of various types are dealt with. The clear and simple colour illustrations are of great assistance to the student, and together with the lucid text provide a non-mathematical treatment of the subject. Also briefly listed are other types of semi-conductor devices, apart from the point contact and junction transistors, some of which are still in the development stages.

PREMIER RADIO CO. LTD. have now opened a new branch of their well-known business at 23 Tottenham Court Road, W.1. In the middle of the West End, just 2 minutes from Tottenham Court Road Underground Station, this new shop includes an elaborately fitted Hi-Fi demonstration room complete with the Premier range of amplifiers and featuring various other well-known amplifier types and makes. A complete range of Do-It-Yourself kits, including radio, radiogram, tape recorder and t.v. kits are on show and available from stock. Every type of radio kit from a 1-valve receiver to the "Mayfair" t.v. are included in the available stock.

MAGNETIC FERRITES

YOU MAY MEET

by R. GAUSDEN

COMING INTO INCREASING USE IN ALL kinds of radio, television and general electronic gear is a range of relatively new materials known as "ferrites." Their main purpose is to replace the usual laminated magnetic cores used in inductances and transformers by a core of small physical dimensions giving low conductivity, high initial permeability and reasonable saturation qualities, beside certain other advantages which, in many cases, make their use preferable to the laminated core we know so well.

As far ago as 1909, German patents were taken out by G. Hilbert covering non-metallic substances such as magnetic iron oxides and ferrites which embodied the necessarily high resistivity required for low eddy current losses. Unfortunately these early substances offered low permeability and high total losses, besides being non-consistent when formed. Of recent years, great strides have been made in embracing more desirable properties in these non-metallic substances so that today a considerable range is available, and it is thought that the amateur experimenter and constructor should be aware of the facilities provided in this field as they are now available for his hobby.

One form of non-metallic ferrite is known by the proprietary name of Ferroxcube, and is made and distributed by Mullard Ltd. in a great variety of shapes and forms, some of which are detailed below. This material is not to be confused with the iron dust-core found in permeability tuned inductances such as i.f. transformers. The dust iron-core is a simple bonded powder; whereas Ferroxcube is a homogeneous magnetic material containing no air gaps between its constituent crystals, and is manufactured by processes similar to those employed in the manufacture of ceramics, and possesses rather the same kind of mechanical properties. If air gaps are intentionally introduced into the magnetic circuit, as is sometimes the case, the effect is to increase the "Q" obtainable from the inductance in a specified frequency range.

The most widely used types and grades of Ferroxcube are as follows:

Type A—a manganese zinc ferrite

Type B—a nickel zinc ferrite, and

Type D—a magnesium manganese ferrite

Type A is divided into four grades, A1, A2, A3 and A4, the various applications where they may be found being:

A1—for high "Q" coils requiring low temperature co-efficient and high stability in the range of 1 kc/s to 500 kc/s.

A2—for t.v. line output transformers and similar applications requiring a higher flux density.

A3—for high flux density applications, being an improved version of A2.

A4—for pulse transformers. This grade has the highest value of all the Ferroxcubes for initial permeability, which makes it also eminently suitable for wide-band (low power) communication transformers.

Type B consists of five grades and differs from Type A in that its generally lower values of permeability and flux density and very high values of resistivity result in considerably improved high frequency characteristics. The five grades cover the range of 500 kc/s to 200 Mc/s. The various grade applications are given as:

B1—similar to A1 except that the higher resistivity makes it more suitable where large piece parts are used for tuned applications at high frequency.

B2—most suitable for aerial rods and tuned applications over the range 1 Mc/s to 2 Mc/s.

B3—for tuned applications over the range 2 Mc/s to 5 Mc/s.

B4—for tuned applications over the range 5 Mc/s to 20 Mc/s.

B5—for tuned applications between 20 Mc/s and 50 Mc/s.

Type D suitable for switching and storage devices such as are used in digital computers.

D1 and D2—to be selected as required for specific uses in switching devices.

Types A, B and D all have a tensile strength of 2,600lb/sq in, and although not easily broken, these materials must be carefully handled to avoid chipping off sharp edges or corners.

Among all the uses to which the various shapes and sizes of Ferroxcube can be put are the provision of pot core inductors, screening beads for suppressing spurious oscillations in r.f. circuits, and rod aerials for small portable receivers.

The pot core inductors (Mullard Type No. LA23) when used in conjunction with metallised-paper capacitors form a particularly compact loudspeaker cross-over network, a selection of cross-over frequencies being obtainable ranging between 470 c/s and 3,750 c/s, the whole network having unusually low losses. Particulars giving number of turns, associated capacitors, etc., can readily be obtained from Mullard Ltd.

The Mullard Ferroxcube screening beads mentioned above are used for the suppression of unwanted high frequencies which find their way back along feeder lines and cause instability and feedback resulting in parasitic oscillations. Normally, such oscillations are dealt with by rather costly decoupling methods without always achieving 100% success. The remedy now is to thread a tiny

bead of Ferroxcube on to the offending lead, the bead acting as a highly inductive toroidal winding presenting a high impedance to the spurious oscillations. There is, of course, no low frequency loss or d.c. volts drop in the lead and fitting is simplicity itself. The cost per bead is of the order of a copper or two.

For small portable receiver aerials the ferrite rod has brought about a complete revolution in regard to space saving coupled with increased sensitivity and a better signal-to-noise ratio. To be effective a normal frame aerial has to be of relatively large dimensions, and a satisfactory compromise has to be found in regard to the ratio of the coupling transformer in order to deliver a suitable voltage at the grid of the first valve. Nowadays, however, it is possible to choose a suitable size of ferrite rod which will concentrate in a small area the magnetic flux of a largish area. The frame aerial can be replaced, for signal pick-up purposes, by a small coil wound round a $\frac{1}{2}$ in diam. ferrite rod, and the results will be comparable to a good length of "throw-out" aerial across a room without the accompanying inconvenience.

There is no doubt that ferrites are here to play their part in the field of electronics and that an increasingly useful number of applications, mostly of a cost-saving character, will become available as production techniques improve.

New Lightweight Three-in-one Beam Aerial For Radio Amateurs

Amateur radio enthusiasts have long worked to perfect the quality of their signal transmission and reception. A beam aerial that goes a long way towards achieving this aim was recently introduced by the Panda Radio Company of Rochdale, Lancs.

Known as the "Globemaster Minibeam," this new piece of apparatus, which was designed to provide high-gain directional antennae for the three amateur wavebands, was invented by Captain G. A. Bird, G4ZU. It employs a simple lightweight array of antennae, which, together with the unique method of feed enables transmission on three wavebands—10, 15 and 20 metres—eliminating the necessity of tuning or switching. The array is easily erected, requires no elaborate supporting tower and does away with the need for complex arrays. A single feed line to the transmitter is used on all three bands, and no adjustment to the antennae is required when changing from band to band. The performance on each band is equal in every way to that of a comparable single band beam.

The benefits of the ordinary beam aerial are well known—its ability to concentrate a signal in the required direction, to give similar gain on reception, and to reject signals from an unwanted quarter—but its drawback is that a separate aerial is required for

each waveband used in the same way that the televisioner requires separate aerials for B.B.C., I.T.V. and FM. The physical size of the beam aerial is determined by the wavelength required, and to the transmitting amateur concerned with 10, 15 and 20 metres this often results in cumbersome structures, difficult to rotate, and weighing as much as 500lb for the more complex arrays.

In order to overcome structural problems created by a wide range of climatic conditions in various parts of the world, high-tensile aluminium alloys supplied by the Northern Aluminium Co. Ltd. were specified for the "Globemaster Minibeam."

A complete array weighs only 35lb, and the manufacturers claim that it can withstand the worst weather conditions.

Technically speaking, the gain on 10 metres is 9.5db, on 15 metres 7.5db, and on 20 metres 4.5db, over a simple dipole. Expressed as power, this is equivalent to a power gain of 9 on 10 metres, 5.6 on 15 metres, and 2.8 on 20 metres. The front-to-back ratio is 20-30db. To the transmitting amateur in this country, restricted to an input of 150 watts, the use of the beam gives an equivalent power of 1,350 watts on 10 metres, 840 watts on 15 metres and 420 watts on 20 metres, if only a simple dipole were to be used.

Using the

BC 1206A RECEIVER

as a

D/F SET

By "SEAFARER"

THIS DIRECTION FINDER IS BASED ON THE BC.1206A Beacon Receiver now available on the surplus market. This receiver is unique in that it derives both its i.t. and h.t. supply from a 24 volts d.c. supply only. By the use of a special output valve, quite adequate output is obtained, and the overall gain and sensitivity of the receiver is surprisingly good. Its tuning range covers the Light programme on 200 kc/s, several Continental stations, and the D/F beacons in the 280/390 range. These beacons are either marine ones or aircraft air lane indicators.

24 volts d.c. is standard on quite a number of yachts and small craft, and so this D/F set is just ideal for such use. Not only does it provide D/F facilities, but the weather reports radiated in the Light programme for shipping can also be received on it.

A perusal of the article by F. R. Pettit, "Experiments with Loop Aerials," in *The Radio Constructor* of August 1954, revealed that quite a simple loop aerial system should give adequate results. In the interests of simplicity it was decided to use a straightforward screened loop. A friend, who knew a sympathetic plumber, persuaded him to bend up a piece of $\frac{3}{8}$ in copper tube into a circle 10in in diameter. A search through the junk box produced a short length of $\frac{3}{8}$ in diam. brass rod and a socket with flanged base for it to fit into, thus making an excellent bearing upon which to rotate the loop. The

local tinsmith brazed the $\frac{1}{4}$ in brass rod to the loop of copper tube, and a pointer was made up out of a $\frac{1}{4}$ in bore bush and a piece of brass strip. The degree scale was also found in the junk box. It originally came from an old galvanometer. An ordinary drawing protractor would serve equally well.

A $\frac{1}{4}$ in gap was then cut in the top of the copper loop and about 20 turns of thin single-strand plastic-covered wire threaded into the copper loop. The ends of the loop aerial are brought out through two holes drilled at the bottom of the loop. The easiest way of threading the wire into the copper loop may be found to be by cutting the wire up into lengths, bundling them all together and drawing the whole bundle through with a length of guide wire. Then solder each length of wire to the next, checking for continuity with a meter. Insulate the connections with tape, and tape up between the two ends of the copper loop, thus ensuring the required insulated gap in the loop itself. One end of the loop goes to the aerial connection on the receiver, the other is earthed.

Those who wish to use this D/F set on a boat for navigational purposes will find the "Yachtsmen's, Fishermen's and Small Craft" Radio Information Charts, published by the Admiralty, and obtained from Chart Agents, very useful for giving all the information required relating to call signs, frequencies, location, times of operation, day and night-time ranges of the beacons, and so on.

Trade Notes

Kendall & Mousley Ltd., 18 Melville Road, Birmingham 16, have now produced a further booklet for the home constructor of radio equipment. Titled *A Second Selection of Equipment for the Laboratory*, it contains chapters on decade boxes, two bridge ratio arms, low resistance measuring device, remote reading thermometer, a compensated ohm-meter, two electronic multimeters, and useful amplifier circuits for the laboratory, all complete with circuit diagrams, etc. It is available from the above address, price 2s. 6d. per copy.

We are informed that Allen Components Ltd. have now changed their address to 38 Felsham Road, Putney, London, S.W.15. The new telephone number is PUT 3032.

New Exide and Drydex Catalogue

A new Exide and Drydex catalogue has now been prepared for radio and hardware traders, giving details and current prices of Drydex torches, refill batteries and bulbs, Exide i.t. accumulators and Drydex batteries for radio receivers and hearing aids.

The new catalogue, which also contains a comprehensive replacement list showing the Drydex batteries suitable for battery-operated radio receivers, is available from local Exide service agents.

Practical . . .

Q and Dynamic Resistance

by J. A. CUSDIN

MANY BEGINNERS MAY BE MYSTIFIED BY the statement that the Q of a tuned circuit is the ratio of the inductive or capacitive reactance to the r.f. resistance $\frac{X_c}{r} = \frac{X_l}{r} = Q$ and then finding, after having calculated a coil and capacitor combination from charts or abacs, that the working Q is very much smaller, giving less gain and selectivity than expected.

The error will be found to lie in the effective working value of r, due to having omitted to take into account various losses which increase r much above the value obtained from the abacs which is the r.f. resistance of the coil only; in other words, one must add the r of the other components such as capacitor, coil former, valve and valve holder, wiring and switches.

It is already known that at resonance a tuned circuit behaves as a resistance of a value $R_d = \frac{L}{Cr}$ and also that shunting one resistor with another forms a combination having a total resistance less than either.

From the above formula, $R_d = \frac{L}{Cr}$ it will be seen that decreasing R_d causes r to increase, and from the formula $\frac{X_c}{r} = Q$ it will be seen

that any increase in r reduces Q, therefore it appears that the losses mentioned in the second paragraph may be represented as a resistor either in parallel with R_d or in series with r. This is, in fact, so, but to avoid confusion it will now be regarded as a shunt resistor across R_d .

This resistor is another of those invisible components of which there are so many in radio, such as Miller effect or C_{out} of a valve, and this one is composed of insulation losses and dielectric losses in the capacitor, coil former, wire covering, switches and valve holder; proximity of screening or other metal

objects; input resistance (R_{in}) and/or a.c. impedance (r_a) of the valve; anode load or grid resistors. It is possible to place an

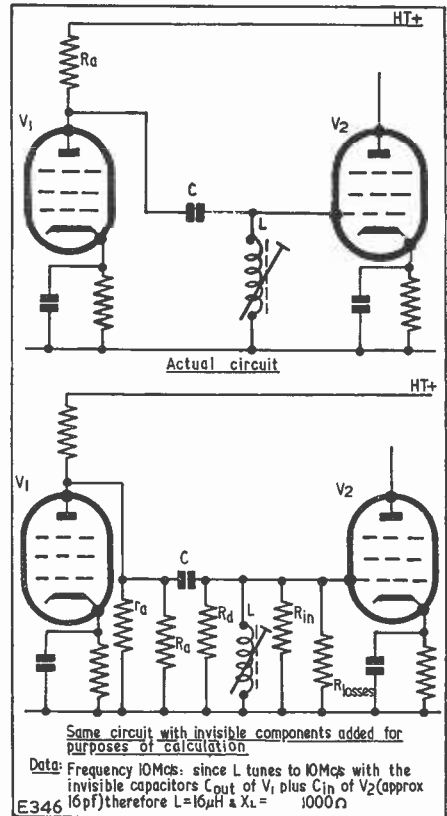

estimated value on each of these factors, but it is usual to lump all of the losses together, thus leaving R_{in} and/or R_g to be denoted

separately. It should, however, be noted that dielectric losses can never be forecast with any great degree of accuracy, so it is usual to measure Q by methods quite outside the scope of this article.

Before becoming completely confused, it is as well at this stage to draw a typical tuned circuit attached to a valve, and then add a number of resistors in parallel with the tuned circuit to represent the items listed in paragraph 5. The example shown is a simple intervalve coupling, and the fact that it is a wide frequency band coupling actually makes the example clearer in spite of expecting to see a conventional i.f.t. coupling between the two valves, which may be either r.f. and f.c., f.c. and i.f., both i.f. or both r.f. stages.

Abacs will give the value of 3.33Ω for the r.f. resistance of the coil, so that the dynamic resistance R_d of the tuned circuit if there were no losses would be $\frac{L}{C_r}$, i.e., $\frac{16,000,000}{16 \times 3.33} = 300k\Omega$.

Typical r.f. pentodes and frequency changers have an r_a of $1M\Omega$; the anode load resistor R_a is $10k\Omega$; R_{in} , say, $150k\Omega$ for a modern valve at 10 Mc/s; and R_{losses} , say, $100k\Omega$ at 10 Mc/s. It may be noted here that R_{in} varies inversely as the square of the frequency, whilst R_{losses} varies with frequency.

Knowing that the formula for resistors in parallel is:

$$R = \frac{1}{\frac{1}{r_a} + \frac{1}{R_a} + \frac{1}{R_d} + \frac{1}{R_{losses}} + \frac{1}{R_{in}}}$$

we may now ascertain that the resultant is $8k\Omega$ and substituting this in the formula

$$Q = \frac{R_d}{X_L} \text{ we find that } Q = 8. \text{ It can now be seen how a high i.f. gives poor selectivity (or wide bandwidth if needed) since bandwidth } 2\Delta f = \frac{i.f.}{Q}, \text{ i.e., } \frac{1.25 \text{ Mc/s}}{8} \text{ to the 3 db points for a single coil tuned circuit, and low stage}$$

gain since gain = $g_m \times R_d$, i.e., $\frac{1,000 \times 8k\Omega}{6} = 48$ for a valve having a g_m of $6mA/V$.

Whilst it is admitted that the low R_a of $10k\Omega$ affects this example very considerably, it is still obvious that even if it was made $1M\Omega$ that the R_d of the coil is greatly reduced by R_{in} and R_{losses} alone, which in an average circuit are each about equal to R_d so that at once the latter is divided by three, and it is for this reason that it is unusual to obtain a Q in excess of 100 and that usually it falls between 50 and 100.

Tabulated List of Electrolytic Condensers Suitable for Transistorised Equipment

Compiled by E. G. BULLEY

Capacity μF	Pk working volts (D.C.)	Length inches	Diameter inches	Type	Manufacturer
0.1	50	0.64	0.18	CE68DA	T.C.C.
0.5	50	0.64	0.18	CE68D	T.C.C.
1.0	50	0.71	0.20	CE69D	T.C.C.
1.0	25	0.64	0.18	CE68C	T.C.C.
1.0	10	0.64	0.18	CE68BA	T.C.C.
1.0	150	1.25	0.25	H21/21	Daly
2.0	12	0.64	0.18	CE68B	T.C.C.
2.0	25	0.71	0.20	CE69C	T.C.C.
2.0	150	1.25	0.25	H22/21	Daly
4.0	6	0.64	0.18	C68A	T.C.C.
4.0	12	0.71	0.20	CE69B	T.C.C.
4.0	50	1.25	0.25	H23/4	Daly
4.0	100	1.25	0.25	H23/6	Daly
5.0	6	1.25	0.25	H210/1	Daly
5.0	12	1.25	0.25	H210/2	Daly
5.0	25	1.25	0.25	H210/3	Daly
5.0	50	1.25	0.25	H210/4	Daly
5.0	100	1.25	0.25	H210/6	Daly
6.0	3	0.64	0.18	CE68AA	T.C.C.

Capacity μF	Pk working volts (D.C.)	Length inches	Diameter inches	Type	Manufacturer
8.0	6	0.71	0.20	CE69A	T.C.C.
8.0	15	0.75	0.26	CE67B	T.C.C.
10.0	6	1.25	0.25	H25/1	Daly
10.0	12	1.25	0.25	H25/2	Daly
10.0	25	1.25	0.25	H25/3	Daly
10.0	50	1.25	0.25	H25/4	Daly
10.0	3	0.64	0.18	CE68AA	T.C.C.
25.0	6	1.25	0.25	H211/1	Daly
25.0	12	1.25	0.25	H211/2	Daly
25.0	25	1.25	0.25	H211/3	Daly
32.0	1.5	0.75	0.26	CE67	T.C.C.
50.0	6	1.25	0.25	H215/1	Daly
75.0	6	1.25	0.375	E217/1	Daly

DB8 TAPE AND WIRE RECORDING

A further selection of articles reprinted from the pages of *The Radio Constructor*, covering both the theory and practical applications. Price 3/- Postage 4d.

DB9 RADIO CONTROL FOR MODEL SHIPS, BOATS AND AIRCRAFT

By F. C. Judd, G2BCX. A comprehensive work on this fascinating subject. Price Standard edition 8/6 Postage 7d. Cloth bound edition 11/6 Postage 8d.



DATA PUBLICATIONS LTD • 57 MAIDA VALE • LONDON W9

CONSTRUCTORS build these at low cost!

PERSONAL PORTABLE RADIO

30/-
Post Free

This little set was designed to give you a real personal portable radio that you can enjoy anywhere without disturbing others. Ideal for the holiday, hiking, fishing, camping, cycling, etc. Use it at home, at the office, in bed, or just anywhere.



Send 2/- for layout, wiring diagram and components price list.

RADIOSETTE

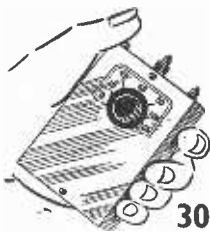

30/-

The ideal low cost transistor pocket radio for the beginner. The circuit utilises the new R.C.S. VARI-LOOPSTICK transistor coil. A specially designed miniature .0004 tuning condenser permits the set to be in a case which fits the palm of your hand. Can be built in 30 minutes.

All components are sold separately, full construction data including plan of parts, 2/-

Postage: Under 10/-, 9d. Under 40/-, 1/6. Over 40/-, post free

ALL-WAVE RADIO

30/-

Ideal for the beginner or for those requiring a simple standby receiver.



This 1 valve S.W. receiver can be built for 30/- from our list of components, which can be purchased separately. It includes valve and 1 coil covering 20-40 metres. Provision is made to increase to 2 or 3 valves if required, and all components are colour-coded so that the beginner can build this set quite easily. Send 2/- for specification, wiring diagram, layout and price list.

R.C.S. PRODUCTS (RADIO) LTD
11 OLIVER ROAD (Mail order only) LONDON E17

TO FIT THE POCKET

NOW AVAILABLE
10th Edition of
AVO
Valve Data Manual
25s. post free



TO FILL THE BILL

19 Ranges

D.C. Voltage	A.C. Voltage
0—100mV.	0—10 V.
0—2.5 V.	0—25 V.
0—10 V.	0—100 V.
0—25 V.	0—250 V.
0—100 V.	0—1000 V.
0—250 V.	
0—1000 V.	
	D.C. Current
	0—100μA
	0—1 mA
	0—10 mA
	0—100 mA
	0—1 A
	Resistance
	0—20,000Ω
	0—2MΩ

Sensitivity:
10,000 Ω/V on D.C. voltage ranges.
1,000 Ω/V on A.C. voltage ranges.

Accuracy:
3% of full scale value on D.C.
4% of full scale value on A.C.

This splendid new AVO Instrument has been developed to meet a definite demand for a sturdy pocket-size multi-range test meter at a modest price, suitable for use on modern electronic apparatus as well as for radio and television receivers, motor vehicles, and all kinds of domestic appliances and workshop equipment.

Readings are obtainable quickly and easily on a very open scale, and range selection is by means of a robust clearly marked rotary switch of the characteristic AvoMeter type. Measurements of A.C. and D.C. Voltage, D.C. Current and Resistance are made by means of only two connection sockets.

THE MULTIMINOR

List Price: **£9/10s.**

complete with Test Leads and clips.
Leather Case if required **£2/6**

Size: 5 $\frac{3}{8}$ × 3 $\frac{3}{8}$ × 1 $\frac{3}{8}$ inches
Weight: 1 lb. approx.



Designed and Manufactured by

AVO Ltd. AVOCET HOUSE · 92-96 VAUXHALL BRIDGE ROAD · LONDON · SW1

Telephone: VICTORIA 3404 (9 lines)

TELETRON Type FX.25

Self-tuned, dual wave
Ferrite rod aerial. 15/- each



Specified for the "Companion" 3 Transistor regenerative pocket receiver.
Type 24 Inductor 3/6 each



TRANSISTOR I.F. TRANSFORMERS

High Q "potted" construction, with Ferrite screw cores. Mounted in screening cans 1" x $\frac{3}{4}$ " dia., 6/6 each. Oscillator coil, 6/6. Transistor type Ferrite rod aerial for MW band, 10/-. Selective crystal diode coil type HAX, 3/- each. Type HAX.L (for LW band), 3/6. Dual wave TRF coils, type A/HF, matched pair, 7/-, with adjustable iron dust cores.

FERRITE ROD AERIALS

Wound on high permeability Ferro-cube rod. No external aerial required.

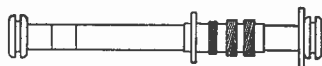

Full sensitivity. Ideal for battery portable receivers. Medium wave, type FRM 4" x $\frac{5}{16}$ ", 8/9. Dual wave type FRD, 8" x $\frac{5}{16}$ ", 12/9. Miniature R.F. Chokes, wound on iron dust cores, with wire end terminations. 2.5 and 5mH, 3/- each; 10mH, 3/6. 200mH top lift Inductors, 6/6 each. Bias rejector coils, 4/6 each. Tape oscillator coils for push-pull operation, 8/6 each.

Send 5d. in stamps for complete data and circuits. All types available from advertisers in this Magazine and local component stockists

THE TELETRON COMPANY LIMITED

266 Nightingale Road . London N9

Telephone HOW 2527

Trade enquiries to sole distributor

S. Mozer Ltd 288 Hedge Lane N13

Telephone PAL 1748 or EDM 7707

DB5 TV FAULT FINDING

Profusely illustrated with photographs taken from a television screen depicting the faults under discussion, and containing a wealth of technical information, with circuits, enabling those faults to be eradicated. Both B.B.C. and I.T.A. transmissions are covered.

PRICE 5/- Postage 5d. Data Publications 57 Maida Vale London W9



BAND 3 TV CONVERTER

185 Mc/s—199 Mc/s

Suitable London, Birmingham, Northern and Scottish
ITA Transmissions

Mk. 2 Model. Latest Cascade circuit using ECC94 and EF80 valves giving improved sensitivity (12 db) over standard circuits, built-in Power Supply a.c. 200-250V. Dimensions only 6½" x 3", ht. 4". Simple and easy to fit—only external plug-in connections. Wired, aligned and tested ready for use. State channel required. Guaranteed. Bargain offer—good results or full refund, only
£3.19.6 Carr. and pkg. 2/6

CONVERTER ACCESSORIES. Band 1-Band 3 Cross-over Unit, 7/6. Var. attenuators 6 db-36 db, 6/9. BBC pattern filter, 8/6. Band 3 aeriols—outside single dipole with 4 yds coax., 13/9. 3-element beam, 27/6. 5-element, 35/-, etc., etc.

MULLARD "3-3" QUALITY AMPLIFIER

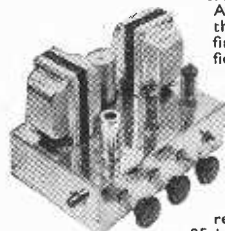

An ideal companion unit to the JASON Tuner. A really first-class 3-valve 3W Amplifier giving hi-fi quality at a reasonable cost. Mullard's latest circuit. Valve line-up: EF86, EL84, EZ81. Extra h.t. and i.t. available for Tuner Unit addition. Variable treble cut and bass boost controls, sensitivity 100mV for 3W output. Frequency response + or - 1db, 40 c/s to 25 kc/s. Complete kit (as illustrated) **£6.19.6**, carr. 3/6. Ready built 8 gns.

FM TUNER-UNIT (87 Mc/s-105 Mc/s) by Jason. Designer Approved Kit of Parts for only 5 gns, post free. Set of 4 spec. valves 30/-, post free. Illustrated handbook with full details, 2/-, post free. 48-hr alignment service, 7/6, p. & p. 2/-

CONDENSERS. Mica or S. Mica. All pref. values. 3pF to 680pF, 6d. each. Ceramic types, 2.2pF to 5,000pF, 9d. each. Tubulars, 450V, Hunts and T.C.C. 0.0005, 0.001, 0.005, 0.01 and 0.1, 350V, 9d.; 0.02, 0.05, 0.1, 500V Hunts, T.C.C., 1/-; 0.25 Hunts, 1/6; 0.5 Hunts, 1/9; 0.001 6kV T.C.C., 5/6; 0.001 20kV T.C.C., 9/6

TRANSISTORS. Mfrs. surplus PNP junction type. Audio Type, 800 kc/s, 250mW, 9/6; R.F. and L.O. Mixer Type, 2.5 Mc/s, 19/6. All tested and guaranteed.

TRANSISTOR COMPONENTS. Midget i.f. trans., 315 kc/s, 5/-; Ferrite Slab Aerial (dual range), 13/6; M. and L.W. Osc. and 1st I.F., 11/6; Push-pull interstage trans., 8/6; Push-pull output trans., 8/-; M/coil phone inserts dia. 2", 4/6; M/I dynamic inserts dia. 1½", 3/9

RESISTORS. Pref. values 10 ohms to 10 megohms, 20% tol., ½W, 3d.; ¼W, 5d.; 1W, 6d.; 2W, 9d.; 10% tol., ¼W, 9d.; 5% tol., ¼W, 1/-; 1% h-stab., ½W, 2/-

PRE-SET W/W POTS. TV knurled slotted knob type. 25 ohms to 30,000 ohms, 3/-; 50,000 ohms, 4/-; 50,000 ohms to 2 Megohms (carbon), 3/-

S.T.C. RECTIFIERS. E.H.T. types, K3/25 2kV, 5/-; K3/40 3.2kV, 6/9; K3/45 3.6kV, 7/3; K3/50 4kV, 7/9; K3/100 8kV, 13/6, etc. Mains types: RM1 125V 60mA, 4/9; RM2 125V 100mA, 5/6; RM3 125V 120mA, 7/6; RM4 250V 250mA, 16/-; RM4B type 250V 275mA, 17/6, etc.

LOUDSPEAKERS. P.M. 3 ohm, 2½" Elac, 16/6; 3½" Goodmans, 18/6; 5" R. & A., 17/6; 6" Celes., 18/6; 7" x 4" Goodmans, 18/6; 8" Rola, 20/-; 10" R. & A., 25/-

SPEAKER FRET. Expanded bronze anodised metal: 8" x 8", 2/3; 12" x 8", 3/-; 12" x 12", 4/3; 12" x 16", 6/-; 24" x 12", 8/6, etc. **TYGAN FRET** (Murphy pattern): 12" x 12", 2/-; 12" x 18", 3/-; 12" x 24", 4/-, etc.

RECORD PLAYER CABINETS

Contemporary style rexine covered cabinet in two-tone grey and green. Size 18½" x 13½" x ht. 8½", fitted with all accessories, including speaker baffle board and plastic fret. Space available for all modern amplifiers and auto-changers, etc. Uncut record player mounting board 14" x 13". Cut mounting boards available.

Cabinet Price £3.3.0 Carr. and ins. 3/6

2 VALVE AMPLIFIER (to fit above cabinet), modern circuit with EL84 output, ready built, with 6" speaker and output transformer, **£3.12.6**, carr. and ins. 2/6

RECORD PLAYER BARGAINS

SINGLE PLAYERS—speed BSR (TU8), 92/6; 4 speed BSR (latest model, TU9), 99/6; 4 speed **COLLARO**, 5 gns; 4 speed **GARRARD** (4 S.P.), £7, 10.0, carr. and ins., 3/6
AUTO CHANGERS—3 speed **COLLARO** (RC54), £7, 19.6; 4 speed BSR (UA8), £8, 15.0; 4 speed **COLLARO** (RC456), £9, 15.0; 4 speed **GARRARD** (RC120/4H), 9½ gns; carr. and ins. 4/6. All above models brand new and guaranteed. Fitted latest style lightweight Xtal PU. with turnover head and twin sapphire stylii.

VOLUME CONTROLS

Log. ratios, 10,000 ohms-2 Megohms. Long spindles. 1 year guarantee. Midget Edison type.
No Sw. S.P.Sw. D.P.Sw.
3/- 4/- 4/9
Linear Ratio, 10,000 ohms -2 Megohms. Less switch, 3/- each. **Coax Plugs**, 1/2. **Coax Sockets**, 1/-, **Couplers**, 1/3. **Outlet Boxes**, 4/6

80 ohm cable COAX

STANDARD ¼" diam. Polythene insulated. Grade 'A' only. 8d. yd.
Special. Semi-air spaced polythene. 80 ohm. Coax ¼" diam. Stranded core. Losses cut 50%. Ideal Band 3, 9d. yd

MAINS TRANSFORMERS. Made in our own workshops to top grade spec. Fully interleaved and impregnated. **RADIO AND AMPLIFIER TYPE** 250V 60mA, F.W. sec., 5V or 6.3V 1A rect. 6.3V 2.5A set htrs., 22/6, etc. **C.R.T. HTR. ISOLATION TYPE.** Low leakage with or without 25% sec. boost voltage. Ratio 1:1 or 1:1.25, 2V, 4V, 6V or 13V, 10/6 each. Ditto with mains primaries 200/250V, 12/6 etc.

L.F. CHOKES—10H 65mA, 5/-; 15H 100mA, 10/6; 10H, 120mA, 10/6; 20H 150mA, 15/6
OUTPUT TRANSF.—Standard pentode, 4/6; push-pull 12 watt, 13/6. Small pentode, 3/9. Midget battery pentode (15A, etc.), 4/6

I.F. TRANSFORMER 465 kc/s

Brand new ex-manufacturer's midget I.F.T., size 2½" x ¾" x ¾", dust core tuning. Litz wound coils, High Q. Bargain offer, 7/6 pair

ELECTROLYTICS—ALL TYPES—NEW STOCK

Tubular Wire Ends		Can Types, Clips 3d. each
25/25V, 50/12V	1/9	8+8/450V T.C.C.
50/50V, 4/500V	2/-	8+16/450V Hunts
100/25V, 2/450V	2/-	16+16/450V T.C.C.
8/450V B.E.C.	2/3	32/350V
8/500V Dub.	2/9	32+32/275V Hunts
8+8/500V Dub.	4/6	32+32/450V T.C.C.
8+16/450V T.C.C.	5/-	250/350V B.E.C.
16/450V B.E.C.	3/6	100+200/275V

MIDGET TRANSISTOR TYPES. 2½F, 4½F, 8½F, 6½F, 3/6; 6½F, 10½F, 16½F 3V, 3/6; 32½F 1½V, 3/6
8" P.M. SPEAKER (3 ohms)

Ex. Mfrs.' Units: Rola, W.B., Celestion, etc. All reconditioned and guaranteed. Ideal ext. unit. Bargain, 7/6, carr. 1/6

VALVES—NEW BOXED—ALL GUARANTEED

1R5, 1T4, 7/6; 1S5, 1S4, 7/6; 3S4, 3V4, 8/-; 5Z4, 9/6; 6AT6, 8/6; 6K7, 6/6; 6X8, 8/6; 6Q7, 8/6; 6SN7, 8/6; 6V6, 7/6; 6X4, 7/6; 6X5, 7/6; 7C5, 9/-; 7Y4, 8/6; DF96, 9/-; DF96, 9/-; DK96, 9/-; DL96, 9/-; 35L6 10/6; EABC80, 9/6; EB91, 6/6; EBC41, 10/6; EVC33, 8/6; ECC84, 12/6; ECH42, 10/6; ECH81, 10/6; ECL80, 10/6; EF41, 10/6; EF80, 10/6; EF86, 12/6; EF91, 8/6; EY51 10/6; EZ40, 8/6; EZ80, 8/6; MU14, 9/6; PCC84, 10/6; PCF80, 10/6; PCF82, 10/6; PCL83, 12/6; PL81, 11/6; PL82, 10/-; P23, 11/6; PY80, 9/6; PY81, 9/6; PY82, 8/6; U22, 8/6; U25, 11/6; UY41, 8/6
SPECIAL—1R5, 1T4, 1S5, 1S4 or 3S4 or 3V4 per set 27/6

TRS RADIO COMPONENT SPECIALISTS

70 Brigstock Road

Thornton Heath Surrey



THO 2188. Hours 9 a.m.-6 p.m. 1 p.m. Wed. Terms: C.W.O. or C.O.D. Post and packing up to ½ lb 7d., 1lb 1/1, 3lb 1/6, 5lb 2/-, 10lb 2/9. Bargain lists 3d.



The
Cooper-Smith
High Fidelity
Amplifier type BPI

COMPONENT PRICE LIST

for Main Amplifier as featured in this issue

Buy direct from the Designers to ensure 100% results

All enquiries promptly dealt with

		s.	d.		s.	d.	
R1	} 2.2kΩ ½W, 1% or matched, high stability ... pr.	3	0	C11	16μF, 450V working, Daly...	3	9
R2					Mains transformer, 300-0-300V at		
R3	} 2.2kΩ ½W, 1% or matched, high stability ... pr.	3	0		120mA, 6.3V at 3A ct, 5V at 3A.		
R4					Electro-Voice type A195 ...	47	3
R5	} 120kΩ ½W, 1% or matched, high stability ... pr.	3	0		Output Transformer 7,000Ω A-A,		
R6					3.5/15Ω sec. 12W, tapped at		
R7	} 22kΩ ½W, 10% high sta- bility	6			20% of primary winding. Pri- mary inductance 58H, leakage		
R8					inductance 22.8mH. Electro- Voice type D73... ..	41	0
R9	} 470kΩ ½W, 1% or matched, high stability ... pr.	3	0		Smoothing choke 10H, 110mA,		
R10					200Ω d.c. resistance, Electro- Voice type 101M	21	3
R11	} 4.7kΩ ½W, 20% high sta- bility	1	0		V1 12AU7, Tungstram (inc. P.T.)	18	11
R12					V2 12AX7, Tungstram (inc. P.T.)	18	11
R13	} 220Ω 5W matched within 5%, wire wound pr.	4	0		V3 } 6BQ5, Tungstram (inc. P.T.)		
R14					V4 } pr.	31	2
R15	} 10kΩ 1W, 20%, high stability	9			V5 5Z4, Tungstram (inc. P.T.) ...	16	11
R16					Chassis 12" x 7" x 2", ready punched, bronze finish, with grommets	17	6
R17	} 39kΩ ½W, 20%, high stability	1	0		Group board, 30-way, 2½" wide, with fixing bushes and screws...	4	0
R18					Fuseholder and fuse, 3A	4	0
VR1	2kΩ potentiometer, linear, slider earthed	3	6		Mains selector	1	6
C1	100pF mica	6			2 Valveholders (int. octal) 9d. ea.	1	6
C2	1.5pF ceramic	9			4 Valveholders (B9A) 9d. ea. ...	3	0
C3	1.5pF ceramic	9			Mains plug and socket, Bulgin ...	3	9
C4	0.25μF 350V working	1	1		Speaker plug and socket, 3-pin Cinch	7½	
C5	0.25μF 350V working	1	1		Coaxial plug and socket	2	6
C6	16μF, 450V working, Daly... ..	3	9		S1 Switch, s.p.d.t., with knob ...	3	0
C7	50μF, 25V working, Daly	1	9		Nuts and screws, solder tags, t.c. wire and sleeving	3	0
C8	50μF, 25V working, Daly	1	9				
C9	8μF, 500V working, Daly	3	3				
C10	16μF, 450V working, Daly... ..	3	9				

Complete Kit, with full instructions **£12.12.0**

Built up and tested **£14.17.0**

H. L. SMITH & CO LTD

287/9 EDGWARE ROAD · LONDON W2 · Telephone Paddington 5891

TV TUBES

BRENTWOOD ELECTRONICS LTD

(The TV Tube Specialists)

10 Victoria Road Brentwood
(2 minutes from Brentwood Station)

Offer the Following

RECONDITIONED TV TUBES

Free postage, packing and insurance in all areas, except Eire. 12 months guarantee on all tubes. 10/- allowed on your old tube.

9" TV Tubes	£3. 10. 0
10" " "	£5. 0. 0
12" " "	£5. 0. 0
14" " "	£5. 0. 0
15" " "	£6. 0. 0
17" " "	£7. 0. 0

The above includes the latest 14" and 17" rectangular tubes

Business Hours
9 a.m.—8 p.m.
Saturdays
9 a.m.—6 p.m.

★

Mail order terms
Cash with order

The Walk-around Shop

FOR THESE FINE BARGAINS

ELECTRIC TIME SWITCH Beautifully made clockwork mechanism automatically wound by 6 volt solenoid. The time switch can be set for any period between 30 minutes and 44 days. This robust unit is housed in strong bakelite case 4" in diameter 12/6

Post paid

ROOM THERMOSTATS by well-known manufacturer. 15 amp, 0/250V, a.c. Temperature range 50 to 80°F. Brand new, in cream finish, with installation instructions 15/-

Plus 2/- packing and carriage

WALKIE-TALKIE TRANSMITTER-RECEIVERS. Type 38. Frequency 7.4 to 9 Mc/s. Valved with 4 VP23's and 1 ATP4. Brand new and complete with 2 pairs of earphones, 2 throat microphones, whip aerial, junction box and canvas satchel. 65/-

Plus 5/- postage and packing

RECEIVER TYPE R.1132A.

Frequency 95-126 Mc/s. 11 valve Superhet. Valve line-up: RF. Amp. VR.65; Frequency Changer VR.65; Local Oscillator VR.66; Stabilizer VS.70; I.F. Amplifiers V.R.53's; B.F.O. V.R.53; Detector V.R.54; A.F. Amplifier V.R.57; Output V.R.37 (6J5). Switchable A.V.C. and A.G.C. Variable B.F.O. Circuit diagram supplied with each unit. Easily converted to receive Wrotham band with no alteration to wiring. Conversion instructions available to each purchaser. Size 19" x 10" x 10" standard rack mounting £3. 7. 6

Plus 10/- postage and packing

PROOPS BROS LTD Open all day Saturday
Dept R, 52 Tottenham Ct Rd. W1
Hours 9-6 p.m. Thursday to 1 p.m. LAngham 0141

MONITOR TYPE 28. Consists of VCR138, 6 SP61, 1 5U4, 1 VU120, 3 EA50. 1mA meter scaled 100-0-100 volts. Incorporates Y shift, X shift in μ /secs, focus, sync, bias. Input to X plates switched x20, x5, direct, requires only suitable power pack for use as oscilloscope. 60/-, carr. 10/-

COMMUNICATION RECEIVER R.1155. This magnificent receiver covers 5 ranges: 75-200 kc/s, 200-500 kc/s, 600-1.500 kc/s, 3-7.5 Mc/s, 7.5-18.5 Mc/s. Fully tested before despatch. Complete with circuit and instruction booklet. £8. 10. 0, carriage 10/-

WHEATSTONE BRIDGE. Consisting of four stud switches: 0-10 ohms, 0-100 ohms, 0-Inf. Galvanometer centre zero F.S.D. 2.5mA. Ranges easily extended. Housed in oak cabinet 16" x 7 1/2" x 6". Complete with instructions, 40/-, P. & p. 4/-

HIGH RESISTANCE HEADPHONES. Type No. 2 4,000 ohms. Brand new 11/6 ea. p. & p. 2/-

R109 RECEIVERS. 8 valves 5 APR12's, 3 AR8's covering 1.8-8.5 Mc/s on two frequency bands. Contains 6V vibrator pack and built-in 3 1/2" Goodman speaker, operates from 6V battery, consumption 1 1/4 A. Housed in metal case 13" x 12" x 11". Complete and tested, including circuit. Very good condition. Only 80/-, carriage 7/6

BATTERIES suitable for above giving 8-10 hours continuous running. FOUR 1.5 dry batteries in series, 5/- plus P. & p. 3/6

POCKET VOLTMETERS. Read 0-25V and 0-250V. D.C. Brand new. In leather case. Only 15/-, P. & p. 2/6

INDICATOR UNIT SLC No. 5. Ideal for conversion into an oscilloscope using 139A or ACR 10 tube. Unit consists of 2 VR65's, 1 VR66, various resistors, condensers and pots. Size 11" x 6" x 3". Brand new, complete with modification circuit. 20/-, P. & p. 4/-

MUIRHEAD VERNIER DRIVES. Scaled 0/180 deg. Ratio 25 to 1, 3" dia. 10/6, p. & p. 1/6

BENDIX RECEIVER MN26C. Covering 150-1,500 kc/s in 3 bands. Valves used 5 6K7, 2 6N7, 2 6J5, 1 6F6, 1 6L7. Complete with switching motor and dynamotor. This superb unit has been modified for 12V operation. The ideal Car Radio. With circuit. Only 80/-, carriage 8/6

CONVERTERS. Covering 40-50 Mc/s switched tuning, 8/6; 50-65 Mc/s tunable, 20/-; brand new with circuits. Post 3/6 each

PARMECO CHOKES. BH 100mA 7/6 P. & p. 1/6

VIBRATOR PACKS. 6V input, 250V output at 100mA; complete 4-pin vibrator, OZ4 rectifier. Fully smoothed 25/6 each. P. & p. 2/6

12V Input, 300V output at 150mA. As a bridge rectifier will handle 450V r.m.s. at 120mA. Pack consists of 12V vibrator, 4 metal rectifiers, chokes and smoothing condensers. Only 30/-, carr. 5/-

No. 38 TRANSMITTER/RECEIVER WALKIE TALKIE. Range approx. 5 miles. Covering 7.4-9 Mc/s. Absolutely complete with junction box, headphones, microphones, webbing, haversack. Brand new only 60/-, carr. 7/6

WAVEMETER TYPE W4133. Frequency 154-260 Mc/s, with crystal check and calibration chart. Mains 50 cycle. 50/-, carr. 10/-

R.T.-7/APN-1 ALTIMETER TRANSCIEVER. Brand new complete with 14 valves: 3 12SJ7, 4 12SH7, 2 12H6, 1 VR150, 2 9004, 2 955. Famous wobblator unit, dynamotor, relays 3500 ohms and 6500 ohms. A.F. amplifier. Receiver section covers 400-450 Mc/s. Transmitter sweeps 418 to 462 Mc/s. With manual. Only 35/-, carr. 10/-

Relda Radio Ltd.

(Dept. 'C') 32A Coptic St London WC1
Telephone MUSEUM 9607
(Tottenham Court Road Underground) 4th turning
on left down New Oxford Street

HENRY'S

(RADIO) LTD

5 Harrow Road Edgware Road
Paddington London W2

Opposite Edgware Road Station

PADddington 1008/9

OPEN MONDAY to SAT. 9-6 THURS. 1 o'clock

SEND 6d. FOR 28-PAGE CATALOGUE

TRANSISTORS

JUNCTION TYPE P-N-P

(British Manufacture)

RED-SPOT 800 kc/s Audio Frequency	10/-
BLUE SPOT 1.6 Mc/s Mixer and Frequency Changer	15/-
WHITE-SPOT 2.5 Mc/s R.F. and I.F. Amp.	20/-

All Transistors are Tested and Guaranteed

N.B.—The Red-Spot is similar to Mullard OC71 Transistor Bases 9d. each

METER FOR TRANSISTOR TESTS

Moving coil 2½" meter reading 0-3V and 0-30V. Centre zero. Basic movement 5mA. Ideal for checking voltages or could be basis for transistor tester. 12/6 p.p. 2/6

COLLARO RC/3/554

3-speed single player with crystal turnover pick-up type "T." £6.19.6, carr. 3/6. Brand new in original carton

COLLARO RC456

4 speed auto-changer. Latest type with crystal turnover pick-up £9. 15. 0

TRANSISTOR SIGNAL TRACER

Complete Kit with 2 Transistors, components, phones, with circuit and plastic case 42/6

TRANSISTOR SQUARE WAVE GENERATOR

Complete Kit with 2 Transistors, components, circuit and plastic case 25/-

DIODES

B.T.H. Germanium	1/6
Mullard OA74	2/6
1N21	3/6
1N22, 1N23, 1N21A	5/-

MODEL-MAKERS' MOTORS

Two types available, 12 or 24V with ¼" spindle, 10/- each

6V VIBRATOR PACKS

Output 120V 30mA. Brand new ... 12/6

SPUTNIK SPECIAL

Reception Set 208 SHORT-WAVE RECEIVER
10 Mc/s-60 Mc/s (5-30 metres)

R.F. STAGE and B.F.O.

Complete with 6 valves: 2 6K8G, 2 EF39, 1 6Q7G, 1 6V6G and metal rectifier. Built in 6¼" p.m. Speaker, Muirhead slow-motion drive. Air tested and guaranteed. Input 6V d.c. and 100/250V a.c. Complete in metal transit case.

ABSOLUTE BARGAIN £6/19/6 carr. 15/6

Valves - Valves - Valves

We have over 300 different types of British and American valves in stock. Send for 28-page Catalogue for further details of valves, components, etc.

TRANSMITTER RECEIVER

Army Type 17 Mk. II

Complete with valves, high resistance headphones, hand-mike and instruction book and circuit.

- Frequency range 44.0 to 61 Mc/s
- Range approximately 3 to 8 miles
- Power requirements: Standard 120V h.c. and 2V i.c.

Ideal for Civil Defence and communications

BRAND NEW 59/6

Calibrated Wavemeter for same, 10/- extra

5-VALVE A.C./D.C. PORTABLE RADIOGRAM CHASSIS THREE WAVE BAND SUPERHET 200/250V A.C./D.C. (With Internal Aerial)

Short Wave 160-50m. Medium Wave 187-575m. Long Wave 900-2,000m. (With gram. switching.) Well-known manufacturer's product complete with five Marconi valves, type: X109, W107, DH107, N109 and U107, and 7" x 4" elliptical speaker. Ideal for Portable Radiogram. Chassis size 10" x 4" x 4"

£7.12.6 P.P. 7/6

Also available as above at the same price, similar chassis with following specifications: Short Wave 11.27-31.9m. Short Wave 31.2-91m. Medium 187-575m. and gram. switching.

WALKIE-TALKIE TRANSMITTER/RECEIVER ARMY TYPE "38"

Complete with 5 valves in new condition with circuits. These sets are sold without guarantee but are servicable 22/6 p.p. 2/6. Headphones 7/6 per pair. Junction box 2/6. Microphone 4/6. Canvas Bags 4/-, Aerial Rods 2/6.

"373" MINIATURE 9.72 Mc/s I.F. STRIP
The ideal FM Conversion Unit as described in P.W. April/May 1957. Complete with 6 valves: 2 EF91, 2 EF92 and EB91. I.F.T.s, etc., in absolutely new condition. With circuit.

12/6 (less valves) 42/6 (with valves)
Postage 2/6 on either type

The "TRANSISTOR - 8"

Push-Pull Portable Superhet

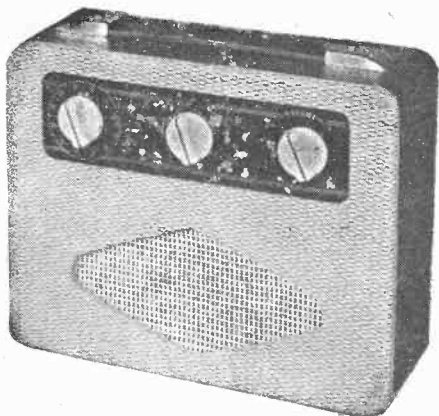

Can be built for £11/10/-

TEN STAR FEATURES

- ★ 8 specially selected Transistors
- ★ 250 Milliwatts output push-pull
- ★ Medium and Long Waves
- ★ Internal Ferrite Rod Aerial
- ★ 7" x 4" elliptical Speaker
- ★ Drilled plastic Chassis 8½" x 2½"
- ★ Point to point wiring and practical layout
- ★ Economical. Powered by 7½V battery
- ★ Highly sensitive
- ★ Attractive lightweight contemporary case

This Portable 8-Transistor Superhet is tunable for both Medium and Long Waves and is comparable in performance to any equivalent Commercial Transistor Set. Simplified construction enables this set to be built easily and quickly into an attractive lightweight cabinet supplied.

We can supply all these items including cabinet for **£11.10.0** All parts sold separately

Send for circuit diagrams, assembly data illustrations and instructions, and full shopping list FREE, post 3d.

N.B.—Pair of XC101's supplied at additional cost of 40/- Call and hear demonstration model

As featured in August issue and described on page 28

ALL PARTS FOR "CONTESSA" TRANSISTOR PORTABLE IN STOCK

"EAVESDROPPER"

THREE-TRANSISTOR POCKET RADIO

(No Aerial or Earth required)

Variable tuning—medium wave. Total cost, as specified including Transistors, Transformers, Coils, Condensers and Battery, etc., with circuit, plastic case and battery.

All items sold separately **77/6** POST FREE

With miniature hearing aid **90/-**

With balanced armature **82/6**

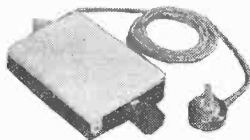

MINI-TWO

2-TRANSISTOR MINIATURE POCKET RADIO

The smallest transistor set offered on the market. Variable tuning. Drilled chassis, plastic case size 3" x 2" x ¾", miniature hearing aid, 2 transistors and all components including 1½ volt battery, circuits and full practical layout diagrams.

Total cost **49/6** complete

"HOMELIGHT"

2-TRANSISTOR PERSONAL PORTABLE

Variable Tuning

We can supply all components including 2 transistors, diode, resistors, condensers and miniature hearing aid and plastic case, size 4½" x 2½" x 1½", and 1½V battery for 52/6. All items sold separately.

HENRY'S RADIO LTD · 5 HARROW ROAD · LONDON W2

TERMS AVAILABLE

TV CHASSIS

£19.19.6

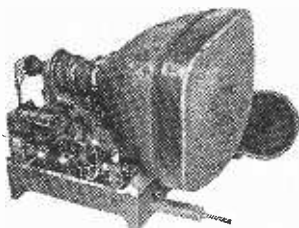

Latest improved circuits. Higher E.H.T. (brilliant picture). Improved sensitivity (for greater range). Chassis easily adapted to any cabinet. 17" rectangular

tube on adapted reconditioned chassis. All channels. 12 months guarantee on tube, 3 months guarantee on valves and chassis. Valve line-up (5 valves): 6SN7G, 6V6, EY51, 2 6D2's; others: 6L18, EL38, 7 6F1's. With 5 valves £21.19.6. With all valves £25.19.6. Ins. carr. (incl. tube) 25/- . State B.B.C. channels and I.T.A. if Turret Tuner required). Turret tuner 50/- extra.

14" TV CHASSIS, TUBE & SPEAKER £13.19.6
As above with 14" round tube. Less valves. 3 months guarantee. With 5 valves, £15.19.6. With all valves, £19.19.6. Turret tuner 50/- extra. Ins. carr. 25/- (incl. tube).

DENCO RADIOGRAM CHASSIS 97/6

3 and 4 waveband turret tuned. S/her. A.C./D.C. chassis with 6" or 8" speaker. Size 8½" x 10" x 12". Valve line-up: CCH35, EF39, EBC33, CL33 and CY31. (CIC or dropper.) Ins. carr. 7/6



SUPER CHASSIS 99/6
5 valve superhet chassis including an 8" speaker. 4 control knobs (tone, volume, tuning, w.c. switch). 4 waveband with position for gram. P.U. for extension speaker. A.C. P. & p. 5/6

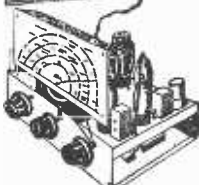

POPULAR RADIO OR R/GRAM CHASSIS 39/9
3 w/band and gram, s/her. 5 valve international octal. Ideal table gram, but still giving high quality output. 4 knob control. 8" p.m. speaker, 7/9 with order. Set of knobs, 2/- . Chassis 12" x 6" x 9". Less valves. Ins. carr. 5/6



TV CONSTRUCTOR CHASSIS

Power Pack & Amplifier, 19/6. O.P. stage 6V6 with o.p. trans. Smoothed h.t. 350V 250mA. 6.3V 5A, 22V 3A, 6.3V 4A, 4V centre tapped. Less valves. FREE less valves. FREE drawing. Carr. 5/6. **Timebase, 7/9.** Including scanning coil, focus unit, etc. Less valves. FREE drawing. P. & p. 2/6. **Sound and Vision Strip, 19/6.** Superhet. Complete s/vision strip. Less valves. FREE drawing. P. & p. 2/6. **CHASSIS, 1/-** each, 6 or 8 valves. Latest type midget valve design for AM and FM. New cadmium-plated on s.w.g. steel. 12½" x 7½" x 2½". P. & p. 1/6. Post on 4, 3/- . 12 for 10/- . Carr. 5/-

MIDGET Ever-Ready BATTERYMAX, 1/9
"B" type battery, 22½V No. B155. Ideal for midget or personal radio, hearing aid or photography flash. Size ½" x 2". Post 3d. 6 for 7/- . Post 6d. 12 for 12/- . post 9d.



RECTANGULAR TV TUBES

17" £7.10.0

14" £5.10.0

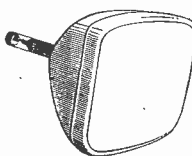

12 months guarantee. 6 months full replacement. 6 months progressive. Made possible by the high quality of our tubes. Ins. carr. 15/6. **Special Offer**

of 14", 15", 16" TV Tubes at £5. Convert your 9", 10", 12" to our special offer of 14", 15", 16" Round Tubes at £5. Details on "How to do it Yourself" in our Free catalogue. **12" TV Tubes, £6.** 3 months guarantee on all round tubes. 15/6 ins. carr. on all tubes.

ELECTRIC CONVECTOR HEATER 99/6

Cleaner, cheaper, safer than paraffin. A.C./D.C. Switched for 1 or 2 kW. 200-250V. Illuminated grille. Size 26" x 18" x 7½" deep. Ins. carr. 10/6

ELECTRIC FIRES, 17/6. Hammered finish. A.C./D.C. 200-250V. Post 3/6



BEAUTIFUL EXTENSION SPEAKERS, 29/9

Fitted with 8" p.m. speaker, W.B. or Goodmans, of the highest quality. Matching to any receiver (2-5 ohms). Switch and flex included. Un-

repeatable at this price. Money back guarantee if not completely satisfied Ins. carr. 3/6

8" P.M. SPEAKERS, 8/9. At this price you can have one in every room. Let the lady of the house listen to that radio or TV programme! P. & p. 1/9

BOXED VALVES 3 MONTHS GUARANTEE

SP61	4/9	6N7GT	4/9	CV18	3/9	EF37	4/9
1S5	4/9	6SG7	3/9	EB34	1/9	ECH81	10/9
3A8	3/9	77	3/9	EB91	6/9	EF50	2/9
4D1	2/9	8D2	3/9	ECC81	8/9	EL32	6/9
6B8	3/9	8D3	7/9	ECH42	8/9	EL91	3/9
6F12	7/9	12AU7	5/9	EF39	6/9	PEN45	3/9
6D2	6/9	12BE6	6/9	EF41	8/9	TT11	6/9
6H6M	1/9	2C22	3/9	EF91	7/9	RL37	1/9
6K7	3/9	12SJ7	1/9	DF66	5/9	Z77	7/9

American Types UX All at 3/9 each
18 75 80 25RE 42
78 1D6 6A7 6D6 6C6
Barretters 301 and 302 also at 3/9 each

SELF-FEED SOLDERING, 19/6. 6-12V, 100-125V, 6-12V, 200-240V.. 35/6. Made for the American market. Car battery or mains. Export quality. Complete in light carrying case. Reel of solder and spare parts. P. & p. 2/9. Export enquiries invited.

CO-AX. CABLE 6d. yd. Good quality, cut to any length. Allow 1/6 on 20 yds, 45/- 100 yds. P. & p. 3/6

INSULATING TAPE, 1/6. 75ft x ½" wide, finest quality. Large roll in metal container. P. & p. 9d.

TV AERIAL, 25/6. For all I.T.A. and FM channels. For outdoor or loft. 3-element type. P. & p. 2/6

CAR RADIO AERIALS, 6/9. Whip antennae, 50" long, collapsing to 11". One hole fixing. Post 1/-

HEADPHONES, 1/9. Single earphone and band, C-LR type. Ideal for crystal sets, extension on radio, etc., P. & p. 1/3

Send for FREE 1958 Catalogue

Liverpool St. to Manor Park Stn.—10 mins.

OPEN SATURDAY ALL DAY

DUKE & CO

(Dept. 1) 621/3 Romford Road Manor Park E12

Telephone ILF 6001/3

SMALL ADVERTISEMENTS

Readers' small advertisements will be accepted at 3d. per word, including address, minimum charge 2/- . Trade advertisements will be accepted at 9d. per word, minimum charge 6/- . If a Box Number is required, an additional charge of 2/- will be made. Terms: Cash with order. All copy must be in hand by the 8th of the month for insertion in the following month's issue.

PRIVATE

FOR SALE English Electric 1550 TV FM vision, sound and timebase chassis. Mazda CRM152B tube, £10. "Laverna," 1 Fairfield Approach, Wraysbury, Bucks

FOR SALE Latest Collaro (digit) tape deck, amplifier, power pack, speaker, tapes, etc., practically completed, everything necessary for complete portable, bargain for constructor, £25. Old Lane tape deck; books: "Radio Engineer's Handbook" by Henney, cost £4.10.0; "Foundations of Wireless," 5th edition; "Short Wave Wireless Communication" by Ladner & Stoner; "TV Explained" by Miller and "Principles of TV Reception" by Keen. Offers? Box No. E149.

HIGHWAYMAN Unused, mint condition £6. Snewin, 14 Woodlands Gardens, London, E.17.

NEW SWITCH-TUNED FM UNIT with a.f.c. Gold Hammer panel engraved Home, Third, Light, £10.10.0. With internal power supply, £12.10.0. Write for details. Box No. E137.

MAGAZINES. Back copies of *QST*, *Radio CQ*, *Wireless World*, *R.S.G.B. Bulletins*, *Short Wave Magazine* and *Amateur Radio* (Australian). All at 1/- each plus postage. Send SAE stating wants. Box No. E150.

FOR SALE RCA AR77 Communications receiver, complete and in working order, £18 including carriage. Box No. E151.

WANTED Woden UM4 Multimatch Modulation transformer, or similar; also Labgear Wide Band multiplier unit. Box No. E152.

FOR SALE "Paragon" Tape Recorder. This is the original prototype from which articles were prepared. In good working order throughout. Owing to the original Truvox deck being opposite to the now standard direction of rotation, this recorder is offered at the favourable price of £15. Buyer collects. See below.

HALLICRAFTERS SX24 communications receiver, with manual. Has double-conversion 85 kc/s 2nd i.f. strip built in, in place of power supply. External power unit giving 250V at 120mA, 150V stabilised, and 6.3V at 5A required. Price £15, buyer collects. See below.

FOR EITHER of above, please phone KILburn 0373 (London) Monday-Friday evenings or Saturday for appointment.

continued on page 447

NEW SURPLUS . . .

1A3	2/6	6Q7GT	9/6	866A	12/6	EL91	7/6
1L4	5/-	6SA7M	7/6	959	8/6	EM80	10/-
2A3	8/6	6SG7M	7/6	1616	5/-	EY51	11/6
2X2	3/6	6SJ7M	7/6	1629	4/-	EZ40	8/6
3A4	6/6	6SK7M	6/6	EAS0	1/6	EZ80	8/6
3A5	9/6	6SL7GT	7/6	EABC8010/-		HK24G	25/-
3Q4	8/6	6SN7GT	6/6	EAC91	4/6	KT33C	9/6
5B/254M	21/-	6SQ7M	7/6	EAF42	10/6	PCC84	10/6
		6X4	6/6	EB34	2/6	PCF82	11/-
5R4G	10/6	6X5GT	7/6	EB91	6/6	PL82	9/6
5U4G	8/6	7B7	9/-	EBC33	7/6	PL83	10/6
5Y4G	6/6	7C5	9/-	EBC41	10/6	PC183	12/6
6AC7M	5/-	7C6	9/-	EBF80	10/-	PY80	9/6
6AG5	3/6	7S7	10/-	EBF89	10/-	PY81	10/-
6AK5	5/-	7Y4	8/6	ECC82	9/6	PY82	9/6
6AL5	6/6	12A6M	7/6	ECC83	9/6	PY83	11/6
6AM6	7/6	12AT6	8/-	ECC84	11/-	R19	12/6
6AQ5	8/6	12AT7	9/-	ECC85	10/6	SP61	3/-
6AT6	8/-	12AU6	9/-	ECC80	13/6	TT11	4/-
6AU6	8/6	12AU7	8/6	EFC82	11/6	UA42	10/6
6B8G	4/6	12BE6	8/6	ECH42	10/6	UBC41	10/6
6BA6	8/6	12C8M	7/6	ECH81	10/-	UBF89	10/6
6BE6	7/6	12Q7GT	9/-	ECL80	10/-	UCC85	10/6
6BR7	11/6	12K7GT	9/-	ECL82	13/6	UCH42	10/6
6C4	5/-	12SC7M	2/6	EF36	4/-	UF41	10/6
6C5M	5/6	12SK7M	7/6	EF37A	8/6	UF89	10/6
6F6M	5/6	12SQ7M	8/6	EF39	5/-	UL41	10/6
6F8G	4/6	35L6GT	8/6	EF41	10/6	UY41	8/6
6G6G	4/6	35Z4GT	8/6	EF50	3/-	UY85	10/-
6I5GT	5/-	35Z5GT	8/6	EF50(S)	5/6	UABC80	
6I5M	6/-	42	7/6	EF55	7/6		10/6
6J6	4/-	50L6GT	9/6	EF80	9/6	VU39	9/6
6K7G	5/6	80	8/6	EF85	10/-	VR150/30	
6K8G	8/6	446A	10/6	EF89	10/6		7/6
6K8M	10/6	801A	7/6	EF91	7/6	VR116	4/-
6H6M	3/6	803	20/-	EL32	4/-	VS70	3/-
6L6G	9/-	808	25/-	EL41	10/-	XP1.5	3/6
6L7M	7/6	830B	15/-	EL84	10/6	Z77	7/6

SPECIAL OFFER

Performance Meters No. 2. Comprising 230V 50 c/s mains trans. 250-0-250V 30mA 6.3V 1½A 5V 2A (60mA h.t. may safely be drawn), 20H choke, 5Z4, Y65 magic eye, 2 EF50, 1 EC52, 1 EA50, dozens of components all in smart grey louvered case 10" x 9" x 9". Made by Parmeko. Brand new and boxed. Unrepeatable component value at only 37/6 each plus 5/- carriage (U.K. only)

Special Valve Offer. 6J6, 6AG5, EL32, TT11, EF39, 6G6G, 6B8G, 37/6 doz. 12SC7M, EF50, 21/- doz.

Command Receivers BC454B. 3-6 Mc/s. Brand new in maker's cartons with 6 valves, 45/- each. Few only used, good condition. 1.5-3 Mc/s, 55/- each

Modulator 67. Contains a.c. power pack, input 230V 50 c.p.s., output 350V 120mA (transformer rated 200mA), 6.3V 5A with heavy duty choke. 5Z4, 11 other valves, switches, pots, etc. Brand new, boxed, 45/- each carr. paid

M.C. Meters. 3½" rd. fl. mtd. (2½" dial), 0-1mA, 26/-; ditto but with very lightly damped movement and scaled 0-10, 18/6 each; 0-30mA, 0-250mA, 0-500mA, 0-2A, 13/6 each; 0-150V a.c. (1mA Basic with Rect.), 28/6; 2½" rd. fl. (2" dial), 0-500 µA, 17/6 each; 0-1mA, 21/- . All post paid

Midget Mains Transformers (same size as std. spkr. o/p). Input 230/250V, o/p 220V 20mA, 6.3V 0.6A. Ditto but 175V 25mA, both types 11/9 each, post paid

Transmitter/Receivers. Army Type 17 Mk. 2. Complete with h.r. phones, hand mike and valves. 44-61 Mc/s. In good used condition, 45/- each or two for 79/6. Carriage paid

Whip Aerials, 4 section screw-in, 12' 6" long (part of BC610 whip), 15/6 each. Carriage paid

"PANL" Crackle Paint, 3/9 tin, post paid

Post 9d.

Free over £2 except where stated
S.A.E. Enquiries

JOHN ANGLIN

385 CLEETHORPE ROAD GRIMSBY LINCS
Telephone 56315

TRANSISTOR CIRCUITS

22/-

by R. P. TURNER

Postage 9d.

A practical work book showing electronic technicians, engineers and experimenters how to use various transistor circuits. Over 150 practical, usable circuits. This book will save the practical man hours of tedious and fruitless hit-or-miss experiments.

THE MODERN BOOK CO

(Dept RC) 19-23 PRAED STREET LONDON W2
Telephone PADdington 4185

Res/Cap Bridge

FOR

35/- ONLY

P. & P. 2/-

For checking all types of resistors and condensers

BUILT IN 1 HOUR!

READY CALIBRATED !!

Stamp for details of this and other instruments

RADIO MAIL DEPT D Raleigh Mews
Raleigh Street Nottingham

G2ACC offers you . .

Catalogue No. 11

9d. post free

56 pages, 108 photographic illustrations,
over 2,000 new guaranteed items by
the leading manufacturers with data.

SOUTHERN RADIO and ELECTRICAL SUPPLIES

Sorad Works Redlynch Salisbury Wilts

QUALITY COMPONENTS

in stock for the

MULLARD 3 VALVE AMPLIFIER

MERCURY SWITCHED FM TUNER

and

510 AMPLIFIERS, FM TUNER circuits 3/6

912 AMPLIFIER, FM TUNER .. 4/-

RADIO CONSTRUCTOR FM .. 2/-

DENCO FM TUNER .. 1/6

G.E.C. "FM PLUS" TUNER .. 2/6

Price Lists available on request

J. T. FILMER

82 DARTFORD ROAD DARTFORD KENT
Telephone DARTFORD 4057

★ VALVES

NEW TESTED AND GUARANTEED

1R5	8/6	6L6G	9/6	DH76	8/6	EP91	8/6
1S5	7/6	6Q7GT	9/6	DK91	8/6	EP92	4/9
1T4	7/6	6SA7	8/-	DK92	9/-	EK32	8/6
354	7/6	6SL7GT	8/-	DK96	9/-	EL32	7/6
3V4	8/6	6SN7GT	8/6	DL92	7/6	EL41	10/-
5U4G	8/6	6SS7	6/6	DL94	8/6	EL84	10/6
5Y4G	7/-	6V6G	7/6	DL96	9/-	EL91	7/6
5Z4G	9/6	6V6GT	7/6	EA50	1/6	EY51	11/6
6AG5	6/9	6X4	7/6	EB91	6/6	EZ35	8/-
6AM6	8/6	6X5GT	7/6	EBC41	9/6	EZ40	8/-
6AL5	6/6	12A7T	9/-	EBC33	8/6	KT33C	7/6
6AT6	8/-	12AU7	9/-	EBF80	10/-	KT66	11/6
6B8	7/6	12AX7	9/-	ECC81	10/6	PCF82	11/-
6B8G	7/6	12K8GT	10/6	ECC84	11/6	PL82	10/6
6BA6	8/6	12K7GT	8/6	ECC82	11/-	PY81	10/6
6BE6	7/6	12Q7GT	8/6	ECH81	10/6	PC84	11/6
6BR7	10/6	35Z4GT	8/6	ECH42	10/6	UCC	8/6
6BW6	8/6	35L6GT	9/6	ECL80	10/6	UBC41	10/-
6G6G	4/9	807	6/9	EF36	7/6	UCH42	10/-
6J5G	5/6	5763	10/6	EF37A	14/6	UF41	10/-
6J5GT	6/6	DAF91	7/6	EF39	5/6	UL41	10/-
6J7GT	8/6	DAF96	9/-	EF41	10/-	UY41	8/-
6K7G	5/6	DF91	7/6	EF80	9/6	W76	8/6
6K8G	9/6	DF96	9/-	EF85	10/6	X65	10/6

Matched Pairs. EL84, 23/-; 6V6G & GT, 17/-; 6BW6, 18/-; KT33C, 19/6; KT66, 27/6; 807 14/6 pair

P.P. Op. Transformers. Mr 3-15 ohms for EL84, 6V6, 6BW6, etc., 18/6; Op. Pen. 50mA, 5/6; 30mA, 4/6

Volume Controls. All values, long spindle. L/S 3/-, s.p. 4/-, d.p. 4/9, ext. spkr. control 3/-

W.W. Pots. Pre-set 3/-; 3W long spindle 5/6, s.p. 6/6

P.M. Speakers. 3 ohm. 5" 16/6, 6 1/2" 17/6, 8" 21/-, 10" 25/-, 12" 30/-

Coaxial Cable. 75 ohm 1/2" stranded, 8d. yd; semi-air spaced, 9d. yd; screen cable single and twin, 9d. yd

Coaxial Plugs 1/- each; Sockets 1/- each

P. and p. 9d. to £1; 1/6 to £2; over £2 post free. C.O.D. 2/6

R. COOPER G8BX

32 SOUTH END CROYDON SURREY

CROYDON
9186

C.R.T. Isolation Transformers with 25% boost. Low capacity, a.c. mains 200-240V. For 2V, 4V, 6.3V and 13V tubes. All 12/6 each; 1-1 for H.C. shorts 10/6

Valveholders. 4, 5, 7 pin English and U.S.A. B7G, B9A, 1.0 Mc. B8G, 9d. each; B7G, B9A with screening can, 1/6; B12A, 1/3. Aladdin formers 1/2" with core, 8d. each

Scotch Boy Recording Tape, 1,200ft reels, 27/-

Jack Plugs, miniature standard 3/-; Sockets 3/-

2-Gang Condensers, .0005 small size, 7/6

I.F. Transformers, 465 kc/s, small size, 7/6 pair
Capacitors, small mica, 5% 1pF to 100pF, 8d.; 120pF to 1,000pF, 9d.; 1,000V wkg. .01, .0015, .0025, .004, .005, 1/- each

Crystal Diodes, G.E.C., 1/6 each

Headphones, lightweight, 4,000 ohm, 16/6 pair

Ceramic Capacitors, close tol. 500V for V.H.F., 9d.
Paper Capacitors, tubular, .01, 1,000V, 1/-; 0.1 to 0.5 500V, 10d.

Paper Blocks, 4 mfd, 1,000V wkg., 3/6

Rectifiers, contact cooled, 250V 50mA, 7/6; 85mA, 9/6

Reaction Condensers, .0001, .0003, .0005, 4/6 each

Heater Trans. 200/240V, 6.3V, 1.5A, 7/6

Resistors, 1/4 and 1/2 W, insulated, 4d. and 6d.; 1W, 8d. 6W W.W., 1/-; 10W, 2/-

Electrolytics. Wire ends. 25/25V, 1/6; 50/50V, 2/-; 12/50V, 9d.; 8/450V, 2/-; 16/450V, 2/9; 16/500V, 3/6; 32/450V, 4/-; 8+8/450V, 4/6; 8+16/450V, 4/6; can types: 16/450V, 3/6; 16+16/500V, 6/-; 32/500V, 6/6; 32/450V, 6/6; 20+20/450V, 4/6; 64+120/275V, 7/6

Wavechange Switches, midget: 1p 12W, 2p 6V, 3p 4W, 4p 3W, 4p 2W, long spindles, 4/6

Toggle Switches. QMB, s.p.s.t., 2/-; s.p.d.t., 3/3; d.p.s.t., 3/6; d.p.d.t., 4/-

Chokes, 80mA, 15H, 8/6; 100mA 10H, 10/6; 150mA 10H, 14/6

Solder, Multicore, 4d. yd; Sleeving 2mm, 3d. yd

SMALL ADVERTISEMENTS

continued from page 445

TRADE

TRANSISTORS Red Spot, 7/6; Blue Spot, 15/-.
Special offer: three Red plus one Blue Spot, 30/-.
J. M. Hendon, 78 Bridge Road, Chessington, Surrey.

BARGAIN PARCEL. Electrolytic condensers, two 32 μ F 275V wkg; two 32+32 μ F 350V wkg; two 16+8 μ F 350V wkg; six 8 μ F 450V wkg; two 250 μ F 6V wkg; volume control pots, two $\frac{1}{2}$ Meg with switch; two $\frac{1}{2}$ Meg with switch; two 2Meg with switch; six germanium diodes. All new and unused components, \pounds 1 post paid. Wilson Bros. (Components), 3 Surrey Road, Harrow, Middx.

A.M.I.P.R.E. For details of suitable study courses (only a limited number of students accepted), send for free Syllabus of Instructional Text. I.P.R.E. Conditions of Membership booklet 1/-; *The Practical Radio Engineer* journal, sample copy 2/3. 6,000 Alignment Peaks for Superhets 6/-. All post free from Secretary, I.P.R.E., 20 Fairfield Road, London, N.8.

PANL, recognised for many years as the unique one-coat black crackle finish. Brush applied, no baking. Available by post in $\frac{1}{4}$ th pint cans at 3/6 from G. A. Miller, 255 Nether Street, London, N.3.

ILLUSTRATED CATALOGUE No. 13 containing over 450 items of Government Surplus and Model Radio Control Equipment, 2/2. Refunded on purchase of goods, 2/6 overseas seamail—Arthur Sallis Radio Control Ltd., Department R.C., 93 North Road, Brighton. Telephone 25806.

LEARN as you do it—we provide practical equipment combined with instructions in Radio, Television, Electricity, Mechanics, Chemistry, Photography, etc. Write for full details to E.M.I. Institutes, Dept. RC47, London, W.4.

JOIN THE INTERNATIONAL S.W. LEAGUE. Free Services to members including Q.S.L. Bureau Translation, Technical and Identification Dept.—both Broadcast and Fixed Stations, DX Certificates contests and activities for the SWL and transmitting members. Monthly magazine, "MONITOR," containing articles of general interest to Broadcast and Amateur SWL's Transmitter page and League affairs, etc. League supplies such as badges, headed notepaper and envelopes. QSL cards, etc., are available at reasonable cost. Send for League particulars. Membership, including monthly magazine, etc., 15/- per annum.—Secretary, ISWL, 86 Barrenger Road, London, N.10.

COILS, COILS, COILS. We can supply coils for all frequencies, r.f. chokes, etc. Send s.a.e. for circuits and data.—The Teletron Co., 266 Nightingale Road, London, N.9.

MORSE CODE TRAINING. Special course for Beginners. Full details from (Dept. RC), Candler System Company, 52 Abingdon Road, London, W.8.

FREE. Brochure giving details in Home Study Training in Radio, Television and all branches of Electronics. Courses for the hobby enthusiast or for those aiming at the A.M.Brit.I.R.E., City and Guilds, R.T.E.B., with other Professional examinations. Train with the college operated by Britain's largest Electronics organisation. Moderate fees. Write to E.M.I. Institutes, Dept. RC28, London, W.4.

continued on page 448

**Yours
by
return
for
only
 \pounds 2.10.0
deposit**

(CASH PRICE \pounds 12.7.6)

PULLIN SERIES 100 MULTI-RANGE TEST SET

21 ranges AC/DC from 100 microamps to 1,000 volts, sensitivity 10,000 ohms/volt. This is the famous Pullin Series 100, now available brand new on the easiest of terms. Send 50/- deposit, balance to be paid in nine monthly payments of 24/6.

Descriptive literature available on request

HOME RADIO

(Mitcham) LTD

187 London Road, Mitcham, Surrey

Telephone: MITcham 3282

Radio Control Mechanisms

by

RAYMOND F. STOCK

A new publication—and the first devoted entirely to the subject of radio control linkage mechanisms. Complementary to *Radio Control for Model Ships, Boats and Aircraft* and, to other books on radio control.

64 PAGES ART BOARD COVER
70 ILLUSTRATIONS

First Edition .. 4/6 plus 4d. postage

DATA PUBLICATIONS LTD
57 MAIDA VALE LONDON W9

Forrest

Transistor Transformers
for Quality Equipment

H. W. FORREST (TRANSFORMERS) LTD.
349 Haslucks Green Road Shirley Solihull
Warwickshire Telephone Shirley 2483

GUARANTEED VALVES — Over 3,000 in stock

EF92, EAC91, 6J6, 6C4, 4J6; 6K7, EC91, 5J6; 6AL5, 6SK7, R10, 3A4, 807, 6J7; 6AM6, EL91, 6X4, 6J6; 6BE6, 6CH6, 6F17, 6F33, 7J6; 12AT7, 12AX7, 12AU7, 6BA6, 6BW6, 8J7; 6BR7, 12E1, 85A2, 2D21, 10J7; EF86, 6L6M, 5B/225M, 5B/251M, 11J6

A. A. W. SKILLMAN
79A FRANCHISE STREET WEYMOUTH

BRASS, COPPER, DURAL ALUMINIUM, BRONZE

ROD, BAR, SHEET, TUBE, STRIP, WIRE
3,000 STANDARD STOCK SIZES

No Quantity too Small List on application

H. ROLLET & CO. LTD

6 Chesham Place SW1 Telephone SLOane 3463
Also at Liverpool Birmingham Manchester Leeds

H.A.C. THE ORIGINAL SUPPLIERS OF SHORT-WAVE KITS

One-valve Kit, price 25/- Two-valve Kit, price 50/-
Improved designs with Denco coils. All kits complete
with all components, accessories and full instructions but
less valves. Before ordering, call and inspect a demonstra-
tion receiver, or send stamped envelope for catalogue.

H.A.C. SHORT-WAVE PRODUCTS (DEPT. R)
11 OLD BOND STREET LONDON W1

TRANSISTORWISE

"RECO" ALL-WAVE 1 TRANSISTOR KIT

A low cost beginner's radio.
Kit includes all parts, transi-
stator, diode, and super sen-
sitive Bell-Phone for private
listening, neat plastic case
and 1.5V battery for months
of dependable listening. Only
29/6.



Parts Price List, Wiring Diagram, 1/- P.O.

"RECO" TRANSISTOR 2 PORTABLE

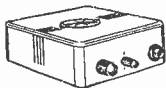

Receives home and Con-
tinental stations. Ferrite
rod aerial. Attractive plas-
tic case, 4 1/2" x 4 1/2" x 1 1/2",
balanced armature output
unit and all parts. 55/-
inc. battery

Parts Price List, Wiring Diagram, 1/- P.O.

"RECO" PORTABLE TRANSISTOR 3

Similar specification to
the "Reco" 2, but uses
high gain frame aerial
mounted on metal chas-
is. Has variable gain
control. 65/- buys all
parts, case and battery.

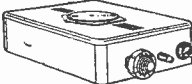

Parts Price List, Wiring Diagram, 1/- P.O.

All parts sold separately

RADIO EXCHANGE CO

(Dept. RC) 27 HARPER STREET BEDFORD

SMALL ADVERTISEMENTS

continued from page 447

SITUATIONS VACANT

SIEMENS EDISON SWAN LTD

TRAINING COURSE

for

TELEPHONE INSTALLATION ENGINEERS and TECHNICIANS

Young men between 20 and 30 with some
experience in electrical or mechanical engineering
are invited to apply for positions under this
scheme. The course consists of six months
intensive training in our works followed by six
months on site installations. Applicants should
be medically fit and must be willing to travel.
Pensionable staff appointments will be given to
satisfactory candidates on completion of course
and on qualification as installation engineers and
technicians. Excellent subsequent prospects for
capable men.

Write with full details of experience and quali-
fications, if any, to

STAFF ESTABLISHMENT OFFICER

REF. 744/93

SIEMENS EDISON SWAN LTD
WOOLWICH LONDON SE18

The Teletron "COMPANION" COMPLETE KIT (as spec.) £4.15.0

(Postage 1/6)



COMPONENT PRICE LIST

Cabinet and chassis, ready drilled	...	8/6
C1 2µF 6V condenser	...	2/6
C2 & C3 500pF & 50pF condensers	each	9d.
C4 0.01µF condenser	...	10d.
L1 Teletron FX25	...	15/-
T1 & T2 Ardenite D239 & D240 trans.	each	10/-
R2 25kΩ Egan switched volume control	...	7/-
R1, R3 to R6 miniature resistors	each	4d.
Tag strip	...	7/d.
Balanced armature reproducer	...	5/6
TR1 R.F. transistor	...	21/-
TR2 & TR3 audio transistors	each	10/-
Wave change switch	...	1/3
Knobs	each	9d.
Circuit diagram with full instructions	...	9d.
*Blue Spot transistor	...	15/-
*L2 type 24 coil	...	3/6

*Not required when using TR1 R.F. transistor

ELEC-RADIO

172A BLACKSTOCK ROAD HIGHBURY
LONDON N5 Telephone CANonbury 1672
Callers Welcome

SCOTTISH INSURANCE CORPORATION LTD



62-63 Cheapside
London EC2

TELEVISION SETS, RECEIVERS AND TRANSMITTERS

Television Sets, Receivers and Short Wave Transmitters are expensive to acquire and you no doubt highly prize your installation. Apart from the value of your Set, you might be held responsible should injury be caused by a fault in the Set, or injury or damage by your Aerial collapsing.

A "Scottish" special policy for Television Sets, Receivers and Short Wave Transmitters provides the following cover:

- (a) Loss or damage to installation (including in the case of Television Sets the Cathode Ray Tube) by Fire, Explosion, Lightning, Theft or Accidental External Means at any private dwelling-house.
- (b) (i) Legal Liability for bodily injury to Third Parties or damage to their property arising out of the breakage or collapse of the Aerial Fittings or Mast, or through any defect in the Set. Indemnity £10,000 any one accident.
- (ii) Damage to your property or that of your landlord arising out of the breakage or collapse of the Aerial Fittings or Mast, but not exceeding £500.

The cost of Cover (a) is 5/- a year for Sets worth £50 or less, and for Sets valued at more than £50 the cost is in proportion. Cover (b) and (ii) costs only 2/6 a year if taken with Cover (a), or 5/- if taken alone.

Why not BE PRUDENT AND INSURE your installation—it is well worth while AT THE VERY LOW COST INVOLVED. If you will complete and return this form to the Corporation's Office at the above address, a proposal w.i.l be submitted for completion.

NAME (Block Letters).....

If Lady, stage Mrs. or Miss

ADDRESS (Block Letters).....

/JB

YOU CAN RELY ON US

We specialise ONLY in radio and electronic components, a comprehensive stock of which are held by us, to supply Government, educational and commercial laboratories. Can we be of some help to you, the experimenter and constructor? ?



The New AVO MULTIMINOR

A first quality pocket instrument

Sensitivity 10,000Ω/V 0 to 1A in five ranges, 0 to 1,000V in 7 ranges. A.C. volts 0-1,000 in 5 ranges. Resistance 0-2 Meg in two ranges.

PRICE £9.10.0 Leather Case 32/6

or 63/4 Deposit and 6 Payments of 22/2 or 9 monthly payments of 23/3

ALL AVO INSTRUMENTS IN STOCK

All specified new components stocked for G.E.C. 912, Mullard 510, Pre-Amps, 20W, 3W, 7W, and Tape Amplifiers. High Stabs., P.F.'s, T.C.C., Hunts, Colvern, J.B., Denco, Taylor, Osmor, Teletron, S.T.C., Westinghouse, Bulgin. All Erie range in 20%, 10%, 5% and 5% High Stabs. Vast ranges of Capacitors, Resistors, Potentiometers, Transformers and Wire-wound Resistors.

82 SOUTH EALING ROAD
LONDON W5 Telephone EAL 5737

RADIO SERVICING CO

52
Booklover

RADIO



BOOKS

Tape and Wire Recording. A selection of articles reprinted from the pages of *The Radio Constructor*, covering both the theory and practical applications. A really useful book on this latest development of the hobby.

4th Edition, 3/-. Postage 4d

TV Fault Finding. Profusely illustrated with photographs taken from a television screen depicting the faults under discussion, and containing a wealth of technical information, with circuits, enabling those faults to be eradicated.

5/-. Postage 5d

FM Tuner Units for Fringe and Local Area Reception. Including optional Tuning Indicator and circuit of Osram 912 Amplifier.

2/-. Postage 2d

The Argonaut AM/FM MW/VHF Tuner Receiver. Describing the construction, alignment, and other details of a high quality tuner (or complete receiver), together with map of present and projected coverage areas.

2/-. Postage 2d

Radio Amateur Operator's Handbook. An indispensable aid to the amateur transmitter and listener, containing all details of information which are constantly required. Prefix Lists, Zone Boundaries, Call Areas, Codes, and Mileage Tables, together with Maps and much other useful operating data.

1957/8 edition, 3/-. Postage 4d

Mercury Switched Tuned FM Tuner Unit. A stable unit employing automatic frequency control and a *ready built* front end.

2/-. Postage 2d

Radio Control for Model Ships, Boats and Aircraft, by F. C. JUDD, G2BCX. A comprehensive work on this fascinating subject.

Standard edition 8/6. Postage 7d

Cloth bound edition 11/6. Postage 8d

The "Eavesdropper." A miniature transistor local station receiver. Complete constructional details of this pocket portable.

1/6. Postage 2d

Radio Control Mechanisms, by RAYMOND F. STOCK. The only book dealing solely with this important part of radio control.

4/6. Postage 4d

All available from your local bookseller, or from

DATA PUBLICATIONS LTD

57 MAIDA VALE LONDON W9

Telegrams **Databux London**

Telephone **CUNningham 6141 (2 lines)**

Published in Great Britain by the Proprietors and Publishers

Data Publications Ltd 57 Maida Vale London W9

Printed by A Quick & Co Ltd Oxford House Clacton on Sea England

Obtainable abroad through the following Collets Subscription Service Continental Publishers & Distributors Ltd William Dawson & Sons Ltd Australia and New Zealand Gordon & Gotch Ltd South Africa Central News Agency Holland "Radio Electronica"

Registered for transmission by Magazine Post to Canada (including Newfoundland)